	Invitation to Tender/ Request for Proposal	Document Identifier	240-114238630	Rev	28	
		Effective Date	07 April 2026			
		Review Date	April 2031			

ESKOM HOLDINGS SOC LTD

INVITATION TO TENDER (ITT)

FOR

Provision of Cooling Towers 1 – 6 Internal Civil Refurbishment during planned (GO and MGO) at Matla Power Station for a period of 5 years as an when required basis.

Tender number	E2950GXMPMAT
Issue date	22 MAY 2026
Closing date and time	17 JUNE 2026 at 10h00
Tender validity period	180 days from the closing date and time
Clarification meeting	<p>Date: 03 June 2026 Time: 12:00am Venue: Microsoft Teams Link: Join the meeting now</p> <p><u>Join the meeting now</u> https://teams.microsoft.com/meet/350779220270844?p=1wMvsZjE8Zj94lqhWR</p> <p>Meeting ID: 350 779 220 270 844</p> <p>Passcode: 22hM9cM9</p> <p>Site visits can be organized by a formal appointment only send to: masinap@eskom.co.za</p>
Tenders are to be delivered to the following address by the stipulated closing date and time. (E-Tendering)	Tenders are uploaded via Eskom Tender bulletin site on the Eskom E- tendering page
Tenders are to be submitted electronically via Eskom E- tendering site by the stipulated closing date and time.	For Closed Tenders please include the link (https://etendering.eskom.co.za where the documents are uploaded and deleted the statement above.

Controlled Disclosure

Anonymously report fraud, corruption at 0800 11 2722/ forensic@eskom.co.za

When downloaded from the document management system, this document is uncontrolled and the responsibility rests with the user to ensure it is in line with the authorized version on the system.

No part of this document may be reproduced in any manner or form by third parties without the written consent of Eskom Holdings SOC Ltd. © copyright Eskom Holdings SOC Ltd. Reg No 2002/015527/30

	Invitation to Tender/ Request for Proposal	Document Identifier	240-114238630	Rev	28
		Effective Date	07 April 2026		
		Review Date	April 2031		

<p><i>Please note it is the responsibility of the supplier to ensure that the tender submission is submitted before the closing time</i></p>	
---	--

Invitation to Tender/Request for Proposal

Eskom Holdings SOC Ltd (hereinafter “Eskom”) invites you to submit a tender for the Provision of Cooling Towers 1 – 6 Internal Civil Refurbishment during planned (GO and MGO) at Matla Power Station for a period of 5 years as an when required basis..

The tender documents are supplied to you on the following basis:

- 1. Free of charge

Eskom has delegated the management of this Invitation to Tender to the Eskom Representative whose name and contact details are set out in the Tender Data. The submission of a tender/proposal by you in response to this Invitation to Tender will be deemed as your acceptance of the Eskom Standard Conditions of Tender which may be accessed at www.eskom.co.za.

All queries and clarifications relating to the Invitation to Tender documents must be addressed in writing to the Eskom Representative. No query or clarification may be addressed to any Eskom official **other than** the Eskom Representative.

Yours faithfully



STANLEY NGWENYA
PROCUREMENT MANAGER
MATLA POWER STATION

Date: 22 May 2026

Controlled Disclosure

Anonymously report fraud, corruption at 0800 11 2722/ forensic@eskom.co.za

When downloaded from the document management system, this document is uncontrolled and the responsibility rests with the user to ensure it is in line with the authorized version on the system.

No part of this document may be reproduced in any manner or form by third parties without the written consent of Eskom Holdings SOC Ltd. © copyright Eskom Holdings SOC Ltd. Reg No 2002/015527/30

	Invitation to Tender/ Request for Proposal	Document Identifier	240-114238630	Rev	28	
		Effective Date	07 April 2026			
		Review Date	April 2031			

1.1 Annexures to the Tender

The following document listed hereunder are attached to this Invitation to Tender/Request for Proposal.

[Annexures that are identified with an asterisk (*) are mandatory for all tenders and must not be deleted or removed. Other annexures must be included/attached only when they are applicable.]

Number	Description	Annexure	Attached (Y / N / N/A)
1.1.1	*Authorisation Form	Annexure A	Y
1.1.2	*Acknowledgement form	Annexure B	Y
1.1.3	*Tenderer's particulars	Annexure C	Y
1.1.4	*Integrity Declaration Form (Suppliers are required to download and read the Supplier Integrity Pact. It is accessible on the Eskom Tender Bulletin via Eskom Supplier Integrity Pact (eskom.co.za) link)	Annexure D	Y
1.1.5	*CPA Requirements for Local Goods/Services	Annexure E	Y
1.1.6	*CPA(IG) for Foreign Goods/Services (if applicable)	Annexure F	Y
1.1.7	SBD 6.2 Declaration Certificate for Local Production and Local Content (only applicable if designated materials are included and then Tenderers will be required to complete and submit Annexures G1 to G4 as evidence of compliance with this requirement).	Annexure G1	Y
	Annexure C Local Content Declaration- Summary Schedule	Annexure G2	Y
	Annexure D Imported Content Declaration – Supporting Schedule to Annexure C	Annexure G3	Y
	Annexure E Local Content Declaration- Supporting Schedule to Annexure C	Annexure G4	Y
1.1.8	*SBD 1 Invitation to Bid must be filled out by all tenderers and submitted with the tender at tender submission deadline	Annexure H	Y
1.1.9	*SBD 6.1 Preference Points Claim Form in terms of PPPFA 2022 regulations	Annexure I	Y
1.1.10	*SBD 4 – Bidders Disclosure	Annexure J	Y
1.1.11	Tax Evaluation questionnaire to determine whether a company, close corporation (CC) or Trust is a personal		

Controlled Disclosure

Anonymously report fraud, corruption at 0800 11 2722/ forensic@eskom.co.za

When downloaded from the document management system, this document is uncontrolled and the responsibility rests with the user to ensure it is in line with the authorized version on the system.

No part of this document may be reproduced in any manner or form by third parties without the written consent of Eskom Holdings SOC Ltd. © copyright Eskom Holdings SOC Ltd. Reg No 2002/015527/30

	Invitation to Tender/ Request for Proposal	Document Identifier	240-114238630	Rev	28	
		Effective Date	07 April 2026			
		Review Date	April 2031			

Number	Description	Annexure	Attached (Y / N / N/A)
	service provider for purposes of PAYE [only to be attached for services type of contracts] .		
1.1.12	Reverse e-auction training acknowledgement form (if applicable)	N/A	
1.1.13	Reverse e-auction process (if applicable)	N/A	
1.1.14	E-tendering Help Manual acknowledgement form	Attached to the enquiry	
1.1.15	E-tendering Help Manual for supplier	Attached to the enquiry	
1.1.16	<p>CIDB Contract Skills Development Goals (CSDG) (if applicable)</p> <p><i>[CSDG is applicable to a contract, or an order issued in terms of a framework agreement that has a duration of 12 months or more, and to:</i></p> <p><i>a) a contract of R5 million or more, in the case of a professional service or service contract or an order issued in terms of such a contract; or</i></p> <p><i>b) a CIDB grading designation of grade 7 or higher, in case of an engineering and construction works, or design and build contract or an order issued in terms of such a contract.</i></p> <p><i>The contractor shall achieve in the performance of the contract the CSDG established in the CIDB Standard for Developing Skills through Infrastructure contracts published in GN 1779, Government Gazette No. 48481 of 28 April 2023].</i></p>		
1.1.17	<p>Contract Participation Goals (CPG) (if applicable)</p> <p><i>[Note that the requirements of a contract participation goal relating to the engagement of targeted enterprises as established in the aforesaid standard applies to:</i></p> <p><i>(a) construction works contracts in the General Building (GB) and to Civil Engineering (CE) classes of construction works;</i></p>		

Controlled Disclosure

Anonymous report fraud, corruption at 0800 11 2722/ forensic@eskom.co.za

When downloaded from the document management system, this document is uncontrolled and the responsibility rests with the user to ensure it is in line with the authorized version on the system.

No part of this document may be reproduced in any manner or form by third parties without the written consent of Eskom Holdings SOC Ltd. © copyright Eskom Holdings SOC Ltd. Reg No 2002/015527/30

	Invitation to Tender/ Request for Proposal	Document Identifier	240-114238630	Rev	28	
		Effective Date	07 April 2026			
		Review Date	April 2031			

Number	Description	Annexure	Attached (Y / N / N/A)
	(b) construction works contracts of an estimated minimum project duration of 6 months; and (c) construction works contracts in which at least 25% of the main contract could reasonably be expected to be subcontracted out in one or more of the following CIDB classes of construction works: i) Civil Engineering (CE) ii) Electrical Engineering Work (EB) iii) General Building Works (GB) iv) Mechanical Engineering (ME)		
1.1.18	Scope of Work	Y	
1.1.19	NEC or other Contract	Y	
1.1.20	Pricing Schedule/BOQ (if not contained in Contract) PDF and a copy in excel format. The upload size per document is 500 megabytes and total submission is restricted to 4 gigabytes.	Y	

1.2 Tender Data

The Tender Data makes several references to the **Eskom Standard Conditions of Tender** and in those instances, the clause numbers are referenced hereunder. If the **Eskom Standard Conditions of Tender** are not attached to the **Invitation to Tender/Request for Proposal**, then tenderers are required to download this from www.eskom.co.za. The **“Tender Data”** as detailed herein shall take precedence over the **Standard Conditions of Tender** in the event of any ambiguity or inconsistency between the two documents.

Clause Number from Standard Conditions of Tender	Tender Data
1.1 Parties	The Employer is Eskom Holdings SOC Ltd The Eskom Representative is: Name: Phindile Masina Tel: 017 615 2945 E-mail: masinap@eskom.co.za
1.3 Tender documents	The Invitation to tender number is: E2950GXMPMAT

Controlled Disclosure

Anonymous report fraud, corruption at 0800 11 2722/ forensic@eskom.co.za

When downloaded from the document management system, this document is uncontrolled and the responsibility rests with the user to ensure it is in line with the authorized version on the system.

No part of this document may be reproduced in any manner or form by third parties without the written consent of Eskom Holdings SOC Ltd. © copyright Eskom Holdings SOC Ltd. Reg No 2002/015527/30

	Invitation to Tender/ Request for Proposal	Document Identifier	240-114238630	Rev	28	
		Effective Date	07 April 2026			
		Review Date	April 2031			

Clause Number from Standard Conditions of Tender	Tender Data
	See the content list above for the tender documents.
1.4 Type of Invitation to Tender/ RFP	This Invitation to Tender/RFP is: <ol style="list-style-type: none"> An open Invitation to Tender
1.6 Eskom's right to accept or reject any tender	The tender shall be for the whole of the contract.
2.1 Eligibility	<p>Tenderers (whether a single company or an incorporated or unincorporated joint venture or consortium) must meet the eligibility criteria stated in the Tender Data. The tenderer, or any of its principles, must not be under any restriction to do business with Eskom or State-Owned Companies.</p> <p><u>Tenderers are ineligible to submit a tender if:</u></p> <ol style="list-style-type: none"> Tenderers have the nationality of a country on any international sanctions list. A tenderer shall be found to have the nationality of a country if the tenderer is a national or is constituted, incorporated, or registered and operates in conformity with the provisions of the laws of that country. This criterion shall also apply to the determination of the nationality of proposed subcontractors or suppliers for any part of the Contract including related services. Tenderers submit more than one [tender/proposal] either individually or as a partner in a joint venture (JV) or consortium, except on an E-Tendering system where there is a limit size (The upload size per document is 500 megabytes and total submission is restricted to 4 gigabytes). Tenders submitted by a joint venture or consortium where the JV/consortium agreement does not explicitly state that the parties of the JV or consortium shall be jointly and severally liable for the execution of the Contract in accordance with the Contract terms. A Tenderer must not have a conflict of interest. All Tenderers found to have a conflict of interest shall be disqualified. Prima facie evidence that a tenderer has a conflict of interest with one or more parties in this [tendering/RFP] process is: <ol style="list-style-type: none"> they have a controlling partner or majority shareholder in common; or they have a relationship with each other, directly or through common third parties, that puts them in a position to have access to information about or influence on the tender of another tenderer, or to influence the decisions of the Employer regarding this bidding process;

Controlled Disclosure

Anonymously report fraud, corruption at 0800 11 2722/ forensic@eskom.co.za

When downloaded from the document management system, this document is uncontrolled and the responsibility rests with the user to ensure it is in line with the authorized version on the system.

No part of this document may be reproduced in any manner or form by third parties without the written consent of Eskom Holdings SOC Ltd. © copyright Eskom Holdings SOC Ltd. Reg No 2002/015527/30

	Invitation to Tender/ Request for Proposal	Document Identifier	240-114238630	Rev	28	
		Effective Date	07 April 2026			
		Review Date	April 2031			

Clause Number from Standard Conditions of Tender	Tender Data
	<p>5. Tenders signed by non-authorized persons.</p> <p>6. Any tenderer that is restricted by National Treasury.</p> <p>7. Any tenderer on the Tender Defaulters list.</p> <p>8. Any tenderer and/or its director/s that is restricted by Eskom.</p> <p>9. A tenderer that sub-contracts 100% of the Scope of Work</p> <p>Eskom will disqualify tenderers that are found not to have met the eligibility criteria.</p>
2.2 - 2.5 Tender Closing	<p>The deadline for Tender submission is: Date: 17 JUNE 2026 Time: 10h00</p> <p>Late Tenders will not be accepted.</p> <p>Tenders are to be uploaded online by clicking on the Eskom E-Tendering page:</p> <p>Tenders are uploaded via Eskom Tender bulletin site on the Eskom E- tendering page</p>
2.7-.2.11 Submitting a tender	<p>For submission at the Tender Office: not applicable,</p> <p>If required, the tenderer must submit an additional copy of the original tender in the specified electronic form at tender submission deadline.</p> <p>OR</p> <p>For Electronic Tender Submissions : applicable,</p> <p>The tenderer must upload the tender via Eskom Tender bulletin site on the Eskom E- tendering page. The documents need to be uploaded under the folder Technical, Commercial, Financial, and other.</p> <p>All documents need to be submitted in a PDF format (The upload size per document is 500 megabytes and total submission is restricted to 4 gigabytes). The price list needs to be submitted in PDF and a copy in excel format.</p> <p>No Zip/condense files can be uploaded No hard copy will be accepted</p> <p>If for some reason you resubmit your tender, then the latest version of the tender submitted will only be accepted and all previous submission/s will be null and void.</p>

Controlled Disclosure

Anonymously report fraud, corruption at 0800 11 2722/ forensic@eskom.co.za

When downloaded from the document management system, this document is uncontrolled and the responsibility rests with the user to ensure it is in line with the authorized version on the system.

No part of this document may be reproduced in any manner or form by third parties without the written consent of Eskom Holdings SOC Ltd. © copyright Eskom Holdings SOC Ltd. Rea No 2002/015527/30

	Invitation to Tender/ Request for Proposal	Document Identifier	240-114238630	Rev	28	
		Effective Date	07 April 2026			
		Review Date	April 2031			

Clause Number from Standard Conditions of Tender	Tender Data
	<p>Please ensure that the submission status is indicated as complete.</p> <p>Supplier Help Manual guide and video can be found on Eskom E-Tendering page</p>
2.12 Tender Validity Period	<p>The tender validity period is 24 weeks:</p> <p>[Note: For construction-related work the initial tender validity must not exceed 12 weeks]</p>
2.15 Site visit and/or clarification meeting	<p>A non-compulsory clarification meeting/site visit with representatives of Eskom will take place as follows:</p> <p>Date: 03 June 2026 Time: 12:00 am Venue: Microsoft Teams</p> <p>Link: Join the meeting now</p> <p>https://teams.microsoft.com/meet/350779220270844?p=1wMvsZjE8Zj94lqhWR</p> <p>Meeting ID: 350 779 220 270 844 Passcode: 22hM9cM9</p> <p>Tenderers must confirm their intention to attend with the Eskom Representative, stating the name, position and contact details of each proposed attendee.</p> <p>Please note that if the tender stipulates that a site/clarification meeting is mandatory/compulsory, then tenderers must attend such meeting. Tenderers that do not attend such mandatory/compulsory meeting will be disqualified and will not be evaluated.</p>
2.16 Seeking clarification	<p>The tenderer will notify Eskom of any clarifications required before the closing time for clarification queries, which is 10 working days before the deadline for tender submission.</p>
2.22 Alternative tenders	<p>Alternative tenders are not allowed.</p>
2.33 Cataloguing	<p>The successful tenderer may be required to provide the cataloguing information per item after contract award and will need to ensure that all materials delivered to Eskom are labelled in line with Eskom's</p>

Controlled Disclosure

Anonymously report fraud, corruption at 0800 11 2722/ forensic@eskom.co.za

When downloaded from the document management system, this document is uncontrolled and the responsibility rests with the user to ensure it is in line with the authorized version on the system.

No part of this document may be reproduced in any manner or form by third parties without the written consent of Eskom Holdings SOC Ltd. © copyright Eskom Holdings SOC Ltd. Reg No 2002/015527/30

	Invitation to Tender/ Request for Proposal	Document Identifier	240-114238630	Rev	28	
		Effective Date	07 April 2026			
		Review Date	April 2031			

Clause Number from Standard Conditions of Tender	Tender Data
	labelling specifications as may be stipulated by Eskom. Where cataloguing is a requirement, the Pricing Schedule must also include a line item for cataloguing, which tenderers are required to quote for. Eskom will pay for the cataloguing.
2.34 Provision of Security for Performance	<p>If the provision of security for performance in the form of a performance bond or a demand guarantee is a requirement, the tenderer must select a minimum of two (2) financial institutions that it is likely to approach from the list provided of Eskom-approved financial institutions.</p> <p>To be advised at a later stage</p>
3.4 Tender Opening	<p>Tenders will be opened at the same date and time as the tender deadline. not applicable,</p> <p>Tenders will be opened on: Place: Eskom E-Tendering. There will be no public opening of tenders. Tenders will be downloaded electronically. Date: 17 June 2026 Time: 10:00 am</p> <p>OR</p> <p>For E-tendering. There will be no public opening of tenders. Tenders will be downloaded electronically.</p>
3.5 Tender Prices	Prices will not be read out.
3.9 Basic Compliance	<p>Basic compliance with this Invitation to Tender requires a tenderer to meet all the following requirements:</p> <p>Basic compliance for this invitation to tender/ RFP are:</p> <ol style="list-style-type: none"> 1. Meet the eligibility criteria for a tenderer 2. Submit a complete tender with commercial, financial and technical information 3. Submission of the mandatory commercial tender returnables as at stipulated deadlines. <p>For E-Tendering, a tenderer's failure to have submitted/uploaded tender documents will render the tender non-responsive.</p>
3.10 Mandatory tender returnables	A tenderer that does not submit mandatory documents by or the complete information required in mandatory documents by the

Controlled Disclosure

Anonymously report fraud, corruption at 0800 11 2722/ forensic@eskom.co.za

When downloaded from the document management system, this document is uncontrolled and the responsibility rests with the user to ensure it is in line with the authorized version on the system.

No part of this document may be reproduced in any manner or form by third parties without the written consent of Eskom Holdings SOC Ltd. © copyright Eskom Holdings SOC Ltd. Reg No 2002/015527/30

	Invitation to Tender/ Request for Proposal	Document Identifier	240-114238630	Rev	28	
		Effective Date	07 April 2026			
		Review Date	April 2031			

Clause Number from Standard Conditions of Tender	Tender Data						
	<p>deadlines as stipulated in the Tender Returnable section of the respective Invitation to Tender/RFP will be deemed non-responsive.</p>						
3.13 Functionality requirements	<p>Functionality requirements are applicable</p> <p>The following criteria will be applicable for this transaction under functionality criteria:</p> <table border="1"> <thead> <tr> <th>Criteria</th> <th>Weight</th> </tr> </thead> <tbody> <tr> <td></td> <td></td> </tr> <tr> <td>Threshold</td> <td>75%</td> </tr> </tbody> </table> <p>Tenderers who do not meet the threshold for functionality scoring will be disqualified</p>	Criteria	Weight			Threshold	75%
Criteria	Weight						
Threshold	75%						
3.15 Evaluation of Price	<p>Prices will be evaluated as follows:</p> <ol style="list-style-type: none"> Inclusive of VAT. Corrected for arithmetical errors. Excluding contingencies in any bill of quantities or activity schedule' Adjusted for any other acceptable variations, deviations, or alternative tenders submitted; and Making a comparison of the Net Present Value of each adjusted tender based on the tendered programme (if provided) and prices, on the estimated effect of Price Adjustment Factors and rate of exchange fluctuations (if applicable) and on other evaluation parameters relating to uncertainty and risk, where applicable. Unconditional discounts will be taken into account for evaluation purposes. Conditional discounts will not be taken into account for evaluation purposes but will be implemented when payment is effected. <p>Prices will be scored out of [80 or 90] points</p>						
3.18 Evaluation of Specific Goals	<p>Specific goals will be scored out of [20 or 10] points in accordance with the PPPFA.</p> <p>If a tenderer fails to submit evidence of its points claim for a Specific Goal, it will not be disqualified. However, it will be awarded 0 points for that Specific Goal.</p>						
3.19 Ranking of tenders	<p>Tenderers will be ranked by applying the preferential point scoring for the [90/10 or 80/20] system. Eskom will add the score from Pricing</p>						

Controlled Disclosure

Anonymous report fraud, corruption at 0800 11 2722/ forensic@eskom.co.za

When downloaded from the document management system, this document is uncontrolled and the responsibility rests with the user to ensure it is in line with the authorized version on the system.

No part of this document may be reproduced in any manner or form by third parties without the written consent of Eskom Holdings SOC Ltd. © copyright Eskom Holdings SOC Ltd. Reg No 2002/015527/30

	Invitation to Tender/ Request for Proposal	Document Identifier	240-114238630	Rev	28	
		Effective Date	07 April 2026			
		Review Date	April 2031			

Clause Number from Standard Conditions of Tender	Tender Data
	and Specific Goals together and rank the suppliers from the highest to the lowest.
3.20 Objective Criteria (if applicable)	<p>Objective criteria are applicable. Please note that Eskom may award the contract to a tenderer other than the highest scoring if objective criteria justify the award.</p> <p>The following objective criteria apply to the tender: Kindly refer to the SDL&I Requirements</p>
3.21 Reverse e-auction (if applicable)	Reverse e-auction is not applicable
Contractual Requirements	<p><u>Mandatory Contractual Requirements that must be included in all tenders are the following: -</u></p> <p><u>Contractual Requirements may include the following: -</u></p> <ul style="list-style-type: none"> • Proof of CSD registration • SHEQ requirements; and /or • SDI&L requirements; and /or • Financial Analysis (Financial statements, ITA34C; PI score, etc.) • 2% CSI – Corporate social Investment <p>Please Note:</p> <p>Contractual Requirements are not evaluation criteria. They will be assessed after the evaluation and ranking of the tenders. Proof that the tenderer recommended for award has met the stipulated contractual requirements must be submitted prior to contract award.</p> <p>Failure to meet stipulated Contractual Requirements by the stipulated deadlines may result in the tenderer being regarded as non-responsive and ineligible for contract award.</p> <p>Failure to meet stipulated Contractual Requirements by the stipulated deadlines may result in the tenderer being regarded as non-responsive and ineligible for contract award.</p>

Controlled Disclosure

Anonymously report fraud, corruption at 0800 11 2722/ forensic@eskom.co.za

When downloaded from the document management system, this document is uncontrolled and the responsibility rests with the user to ensure it is in line with the authorized version on the system.

No part of this document may be reproduced in any manner or form by third parties without the written consent of Eskom Holdings SOC Ltd. © copyright Eskom Holdings SOC Ltd. Reg No 2002/015527/30

	Invitation to Tender/ Request for Proposal	Document Identifier	240-114238630	Rev	28	
		Effective Date	07 April 2026			
		Review Date	April 2031			

Clause Number from Standard Conditions of Tender	Tender Data
3.24 Sign form of Agreement/ Contractual Conditions	<p>The conditions of contract will be the NEC3 Term Service Contract (TSC)</p> <p>Main option:</p> <p>A: Priced contract with Activity schedule W1: Dispute resolution procedure</p> <p>Secondary options:</p> <p>X1: Price adjustment for inflation X2: Changes in the law X5: Sectional Completion X7: Delay damages X9: Transfer of rights X10: Employer's Agent X11: Termination by the Employer X12: Partnering X17: Low service damages X18: Limitation of liability X19: Task Order</p> <p>Z: Additional conditions of contract</p> <p>[For contracts to which CIDB Contract Participation Goals (CPG) are applicable] The recommended supplier shall submit all the documentation (Form A2 Baseline Training Plan, Form A3 Project Interim Report, Form A4 Supervisor Agreement, Form A5 Project Completion Report) that may be required as returnables after contract award as stipulated by Clause 4 of the Contract Skills Development Goals Standard published in GGN 36760 of March 2020.</p> <p>[For contracts to which CIDB Contract skills development goals (CSDG) are applicable] The recommended supplier shall submit all the documentation (Annexure A-Targeted Enterprise Declaration Affidavit; Project Interim Report, Project Completion Report and Declaration) that may be required as returnables after contract award and as stipulated by Clause 3.3 of the Standard for Indirect Targeting for Enterprise Development through Construction Works Contract (<i>published in GN 1779, Government Gazette No. 48481 of 28 April 2023</i>)</p> <p>[In the event that there are further documents/actions that are required during execution of the contract, these must be made</p>

Controlled Disclosure

Anonymously report fraud, corruption at 0800 11 2722/ forensic@eskom.co.za

When downloaded from the document management system, this document is uncontrolled and the responsibility rests with the user to ensure it is in line with the authorized version on the system.

No part of this document may be reproduced in any manner or form by third parties without the written consent of Eskom Holdings SOC Ltd. © copyright Eskom Holdings SOC Ltd. Reg No 2002/015527/30

	Invitation to Tender/ Request for Proposal	Document Identifier	240-114238630	Rev	28	
		Effective Date	07 April 2026			
		Review Date	April 2031			

Clause Number from Standard Conditions of Tender	Tender Data
	contractual conditions and compliance thereto must be managed in terms of the contract.]
2.28 CIDB Requirements (where applicable for Engineering and Construction Works Contracts)	<p>CIDB Requirements are not applicable.</p> <p>1. It is estimated that tenderers must have a Construction Industry Development Board (CIDB) contractor grading of or or higher</p> <p><i>[Insert the best estimate of required Contractor grading designation. The clause above must be omitted: -</i> <i>(i) where the contract involves goods or services; or</i> <i>(ii) the employer promotes potentially emerging enterprise in engineering and construction works.]</i></p> <p style="text-align: center;">OR;</p> <p>1. It is estimated that tenderers must have a CIDB contractor grading of or or higher, or potentially emerging enterprises who satisfy criteria stated in the Tender Data may submit tenders.</p> <p>2. Contractors registered as potentially emerging enterprises with the CIDB that are registered in one CIDB contractor grading designation stipulated or lower than that required in 1 above and who satisfy the following criteria: -</p> <p>a) _____ b) _____</p> <p><i>[Insert the best estimate of required Contractor grading designation; delete “or” where only one class of construction works is applicable: and omit the above clause: -</i> <i>(i) where the contract involves goods or services; or</i> <i>(ii) the employer does not promote potentially emerging enterprises in engineering and construction works.]</i></p> <p style="text-align: center;">OR;</p> <p>Joint ventures are eligible to submit tenders provided that: -</p> <p>3. every member of the Joint venture (JV) is registered with the CIDB.</p> <p>4. the lead partner has a contractor grading designation in the or *class of construction work; or not lower than one level below the required grading designation in the class of works construction works under</p>

Controlled Disclosure

Anonymously report fraud, corruption at 0800 11 2722/ forensic@eskom.co.za

When downloaded from the document management system, this document is uncontrolled and the responsibility rests with the user to ensure it is in line with the authorized version on the system.

No part of this document may be reproduced in any manner or form by third parties without the written consent of Eskom Holdings SOC Ltd. © copyright Eskom Holdings SOC Ltd. Reg No 2002/015527/30

	Invitation to Tender/ Request for Proposal	Document Identifier	240-114238630	Rev	28	
		Effective Date	07 April 2026			
		Review Date	April 2031			

Clause Number from Standard Conditions of Tender	Tender Data
	<p>consideration and possesses the required recognition status;</p> <p>5. the combined contactor grading designation calculated in accordance with the CIBD regulations is equal to or higher than a contractor grading designation determined in accordance with the sum tendered for a or* class of construction work or a value determined in accordance with Regulations 25 (1B) or 25 (7A) of the CIBD Regulations.</p> <p><i>[*insert class of construction work and delete “or...” where only one class of construction works is applicable].</i></p> <p><i>[Please note that only those tenderers that are registered with the Construction Industry Development Board or are capable of being so registered within twenty-one (21) working days from the closing date for submission of tenders in a contractor grading designation as stipulated in the tender data and determined in accordance with the best estimated value of the scope of works are eligible to submit tenders.</i></p> <p><i>Eskom must, within 21 working days from date when contractors offer to perform a construction works contract is accepted in writing, register and publish the award of all contracts equal to or exceeding R10 M inclusive of VAT.]</i></p>
2.29 Contract Skills Development Goals (CSDG) is not applicable]	<p>The CSDG is not applicable to this tender</p> <p><i>[Please note: Contractor shall achieve in the performance of the contract the CSDG established in the CIDB Standard for Developing Skills through Infrastructure contracts (published in GN 1779, Government Gazette No. 48481 of 28 April 2023)</i></p> <p><i>CSDG is applicable to a contract or an order issued in terms of a framework agreement that has a duration of 12 months or more, and to:</i></p> <p><i>a) contract of R5 million or more, in the case of a professional service or service contract or an order issued in terms of such a contract; or</i></p> <p><i>b) a cidb grading designation of grade 7 or higher, in case of an engineering and construction works, or design and build contract or an order issued in terms of such a contract].</i></p>
2.30 Contract Participation Goals are not applicable]	<p><i>[Please note:</i></p>

Controlled Disclosure

Anonymously report fraud, corruption at 0800 11 2722/ forensic@eskom.co.za

When downloaded from the document management system, this document is uncontrolled and the responsibility rests with the user to ensure it is in line with the authorized version on the system.

No part of this document may be reproduced in any manner or form by third parties without the written consent of Eskom Holdings SOC Ltd. © copyright Eskom Holdings SOC Ltd. Reg No 2002/015527/30

	Invitation to Tender/ Request for Proposal	Document Identifier	240-114238630	Rev	28	
		Effective Date	07 April 2026			
		Review Date	April 2031			

Clause Number from Standard Conditions of Tender	Tender Data
	<p><i>Contractor shall achieve in the performance of the contract the Contract Participation Goals (CPG) relating to the engagement of targeted enterprises as established in the CIDB Standard for Indirect Targeting for Enterprise development through Construction Works Contract (published in Government Gazette No. 36190 of 25 February 2013)</i></p> <p><i>The requirements of a contract participation goal relating to the engagement of targeted enterprises as established in the aforesaid standard applies to:</i></p> <p><i>a) construction works contracts in the General Building (GB) and to Civil Engineering (CE) classes of construction works;</i></p> <p><i>b) construction works contracts of an estimated minimum project duration of 6 months; and</i></p> <p><i>c) construction works contracts in which at least 25% of the main contract could reasonably be expected to be sub-contracted out in one or more of the following CIDB classes of construction works:</i></p> <ul style="list-style-type: none"> <i>• Civil Engineering (CE)</i> <i>• Electrical Engineering Work (EB)</i> <i>• General Building Works (GB)</i> <i>• Mechanical Engineering (ME)</i> <p><i>The contractor shall engage targeted enterprise/s in the performance of the contract to the extent that at least 5 % contract participation goal is achieved.</i></p> <p><i>The contractor shall determine the contract skills participation goals expressed in Rands which shall not be less than the contract amount multiplied by a percentage factor.]</i></p>

Please note:

Tenderers are requested to bear in mind Eskom's standard payment terms as stipulated hereunder when submitting tenders and concluding contracts with Eskom:

For contracts valued below R50 000 000 (Fifty Million Rand) including VAT, Eskom is committed to paying Suppliers within 30 days of receipt of undisputed invoices.

For contracts valued above R50 000 000 (Fifty Million Rand) including VAT, Eskom is committed to paying suppliers within 60 days of receipt of undisputed invoices.

Controlled Disclosure

Anonymously report fraud, corruption at 0800 11 2722/ forensic@eskom.co.za

When downloaded from the document management system, this document is uncontrolled and the responsibility rests with the user to ensure it is in line with the authorized version on the system.

No part of this document may be reproduced in any manner or form by third parties without the written consent of Eskom Holdings SOC Ltd. © copyright Eskom Holdings SOC Ltd. Reg No 2002/015527/30

	Invitation to Tender/ Request for Proposal	Document Identifier	240-114238630	Rev	28	
		Effective Date	07 April 2026			
		Review Date	April 2031			

Eskom reserves the right to negotiate with preferred bidders after a competitive bidding process or price quotations should the tendered prices not be market related.

Main contractors/ suppliers are discouraged from subcontracting with their subsidiary companies as this may be interpreted as subcontracting with themselves and / or using their subsidiaries for fronting. Where a main contractor subcontracts with a subsidiary, this must be declared in its tender documents.

A report containing a list of potential sub-contractors may be drawn by accessing the following link: www.csd.gov.za

“Proof of B-BBEE status level of contributor” means-

- (a) the B-BBEE status level certificate issued by an authorised body or person; or
- (b) a sworn affidavit as prescribed by the B-BBEE Codes of Good Practice; or
- (c) any other requirement prescribed in terms of the Broad-Based Black Economic Empowerment Act

1.3 TENDER RETURNABLES

The tenderer must submit the returnable set out hereunder as part of its tender at the stipulated deadline.

NOTE THE FOLLOWING: -

* Returnables required at Tender closing (disqualifiable): -

These returnables are required to be completed, signed (if required on the returnable) and submitted with the tender at Tender closing date and time. If not completed, signed (if required on the returnable) and/or submitted by tender closing, the tenderer will be disqualified.

** Returnable required at Tender closing (non-disqualifiable): -

These returnables are required to be completed, signed (if required on the returnable) and submitted with Tender at Tender closing date and time; however, if not submitted by Tender closing, or submitted with incomplete information or without a required signature, the Procurement Practitioner will, in writing, request the tenderer to submit the returnable within 5 working days. If the returnable is not completed, signed if required and/or received by the Procurement Practitioner within 5 working days of the request, the tenderer will be disqualified.

The 5 working days period does not apply to CIDB proof of grading. Refer to the returnable table the prescribed period for CIDB proof of grading.

Returnables required at Tender Closing date and time for evaluation: -

Controlled Disclosure

Anonymously report fraud, corruption at 0800 11 2722/ forensic@eskom.co.za

When downloaded from the document management system, this document is uncontrolled and the responsibility rests with the user to ensure it is in line with the authorized version on the system.

No part of this document may be reproduced in any manner or form by third parties without the written consent of Eskom Holdings SOC Ltd. © copyright Eskom Holdings SOC Ltd. Reg No 2002/015527/30

	Invitation to Tender/ Request for Proposal	Document Identifier	240-114238630	Rev	28	
		Effective Date	07 April 2026			
		Review Date	April 2031			

These returnables are required to be submitted at tender closing date and time. These returnables will not be requested by the Procurement Practitioner. A tenderer that does not submit the required returnable at stipulated deadline or submits an incomplete returnable; will not be disqualified but will score zero.

Returnable required prior to Contract Award.

Returnables that are mandatory for contract award must be submitted prior to award, completed if completion is a requirement and signed if signature is a requirement.

Reference	Returnable From Suppliers	Returnable required at Tender closing (disqualifiable)*	Returnable required at Tender closing. (Non-disqualifiable)**	Returnable required prior to Contract Award.
Basic Compliance	Electronic copy of the tender in a PDF format. The price list needs to be submitted in PDF and a copy in excel format (The upload size per document is 500 megabytes and total submission is restricted to 4 gigabytes)	√		
Annexure A	Authorisation Form		√	
Annexure B	Acknowledgement Form		√	
Annexure C	Tenderers Particulars		√	
Annexure D	Integrity Pact Declaration form		√	
Annexure E	CPA for local goods/services (if applicable)	√		
Annexure F	CPA(IG) for imported goods/services (if applicable)	√		
Annexure G1-G4	SBD 6.2 -Declaration certificate for local production and content and Annexures G2,G3,G4 [only applicable where designated materials are included]			√
Annexure H (applicable for all suppliers including foreign suppliers)	SBD 1- to be completed and submitted by all tenderers.			√
# Annexure I	SBD 6.1- Preference Points Claim Form in terms of PPPFA 2022 regulations			
Annexure J	SBD 4 – Bidders Disclosure		√	

Controlled Disclosure

Anonymously report fraud, corruption at 0800 11 2722/ forensic@eskom.co.za

When downloaded from the document management system, this document is uncontrolled and the responsibility rests with the user to ensure it is in line with the authorized version on the system.

No part of this document may be reproduced in any manner or form by third parties without the written consent of Eskom Holdings SOC Ltd. © copyright Eskom Holdings SOC Ltd. Rea No 2002/015527/30

	Invitation to Tender/ Request for Proposal	Document Identifier	240-114238630	Rev	28	
		Effective Date	07 April 2026			
		Review Date	April 2031			

Reference	Returnable From Suppliers	Returnable required at Tender closing (disqualifiable)*	Returnable required at Tender closing. (Non-disqualifiable)**	Returnable required prior to Contract Award.
Reverse e-auction training acknowledgement form (if applicable)				√
E-tendering Help Manual acknowledgement form (If applicable)			√	
Additional Documents required in the event of JV: -	Letter of intent to form a JV/consortium or Valid joint venture agreement confirming the rights and obligations of each of the joint venture partners and their profit-sharing ratios.		√	
	Separately written confirmation that the joint venture will operate as a single business entity (incorporated) for the duration of the contract, or this may be included as an obligation within the JV agreement.		√	
	Details and confirmation of a single designated bank account in the name of the JV and independent of the individual JV partners, as set out in the joint venture agreement.			√
# Specific Goals	A tenderer's failure to submit proof that it meets the specific goals will not result in its disqualification. The tenderer will, however, be scored zero for Specific Goals for purposes of PPPFA scoring and ranking.			
Tax Clearance Certificates	A certified copy of a tax clearance certificate is required from foreign tenderers (with a footprint in South Africa but that are not registered on CSD and have not provided a SARS pin number) and local tenderers (that have not provided their SARS e-filing PIN number for verification by Eskom and/or their CSD profile / CSD number). Foreign suppliers with no footprint in South Africa must complete the SBD1 document; however, no proof of tax compliance is required.			√

Controlled Disclosure

Anonymously report fraud, corruption at 0800 11 2722/ forensic@eskom.co.za

When downloaded from the document management system, this document is uncontrolled and the responsibility rests with the user to ensure it is in line with the authorized version on the system.

No part of this document may be reproduced in any manner or form by third parties without the written consent of Eskom Holdings SOC Ltd. © copyright Eskom Holdings SOC Ltd. Rea No 2002/015527/30

	Invitation to Tender/ Request for Proposal	Document Identifier	240-114238630	Rev	28	
		Effective Date	07 April 2026			
		Review Date	April 2031			

Reference	Returnable From Suppliers	Returnable required at Tender closing (disqualifiable)*	Returnable required at Tender closing. (Non-disqualifiable)**	Returnable required prior to Contract Award.
Tax Evaluation Questionnaire (if services contract and was included as annexure)	Evaluation questionnaire to determine whether a company, close corporation (CC) or Trust is a personal service provider for purposes of PAYE			√
Compliance with Employment Equity Act	To the extent that the tenderer falls within the definition of a “designated Employer” as contemplated in the Employment Equity Act 55 of 1998, the tenderer is required to furnish the Employer with proof of compliance with the Employment Equity Act, including proof of submission of the Employment Equity report to the Department of Labour. (South African tenderers only)			√
CIDB (where applicable)	Valid proof of the required CIDB grading designation for the main contractor; JV and /or sub-contractor as may be required in the tender data at tender closing deadline or within 21 working days from the closing date of submission of tenders if this is agreed with the Employer	CIDB 6 CE	√	
NEC or other Contract	NEC or other Contract, completed.	√		
Pricing schedule	Completed pricing schedule (if not already submitted in the NEC or other Contract). For e-tendering price schedule needs to be submitted	√		
	<i>and a copy in excel format.</i> The upload size per document is 500 megabytes and total submission is restricted to 4 gigabytes.		√	
Additional documents required		√		

Controlled Disclosure

Anonymously report fraud, corruption at 0800 11 2722/ forensic@eskom.co.za

When downloaded from the document management system, this document is uncontrolled and the responsibility rests with the user to ensure it is in line with the authorized version on the system.

No part of this document may be reproduced in any manner or form by third parties without the written consent of Eskom Holdings SOC Ltd. © copyright Eskom Holdings SOC Ltd. Reg No 2002/015527/30

	Invitation to Tender/ Request for Proposal	Document Identifier	240-114238630	Rev	28	
		Effective Date	07 April 2026			
		Review Date	April 2031			

Reference	Returnable From Suppliers	Returnable required at Tender closing (disqualifiable)*	Returnable required at Tender closing. (Non-disqualifiable)**	Returnable required prior to Contract Award.
(ECSA/ SACPCMP/CVs/ permits/licenses/ specific registration documents (if applicable to scope of work)				
	MANDATORY CONTRACTUAL REQUIREMENTS SUPPORTING EVIDENCE [applicable to all tenders]			
Mandatory Contractual Requirement	CSD Registration (CSD number/CSD Report)			√
	ADDITIONAL CONTRACTUAL REQUIREMENTS SUPPORTING EVIDENCE [where applicable and as stipulated under tender Data]			
Safety	COIDA - Original certificate of good standing or proof of application issued by the Compensation Fund (COID) or a licensed compensation insurer (South African tenderers only)			√
Quality	[list quality documents here if they are required per scope]			√
Other safety/quality documents as required per scope of works	[list other safety/quality documents here if they are required per scope]			√
Environmental	[list other environmental documents here if they are required per scope]			√
Due Diligence/financial analysis	<ul style="list-style-type: none"> Latest, approved (No draft annual financial statements or managements accounts are allowed for this process) annual financial statements of the tendering company (Not Parent or ultimate holding company), including: 			√

Controlled Disclosure

Anonymously report fraud, corruption at 0800 11 2722/ forensic@eskom.co.za

When downloaded from the document management system, this document is uncontrolled and the responsibility rests with the user to ensure it is in line with the authorized version on the system.

No part of this document may be reproduced in any manner or form by third parties without the written consent of Eskom Holdings SOC Ltd. © copyright Eskom Holdings SOC Ltd. Reg No 2002/015527/30

	Invitation to Tender/ Request for Proposal	Document Identifier	240-114238630	Rev	28	
		Effective Date	07 April 2026			
		Review Date	April 2031			

Reference	Returnable From Suppliers	Returnable required at Tender closing (disqualifiable)*	Returnable required at Tender closing. (Non-disqualifiable)**	Returnable required prior to Contract Award.
	<ul style="list-style-type: none"> ○ Background to the company ○ A signed director's report. ○ A signed auditor's/reviewer's/compiler's/accounting officer's report ○ Statement of financial position ○ Statement of comprehensive income ○ Statement of changes in equity ○ Statement of cash flows ○ Notes to the financial statements. <ul style="list-style-type: none"> ● A signed copy of the public interest score (only applicable to South African entities that are not audited) <ul style="list-style-type: none"> ○ Giving the actual score ○ Indicating whether the company is owner managed or not ○ Confirming whether the annual financial statements were externally prepared or not. ● Copies of the ITA34C for the current & previous years of assessment (only applicable to South African entities that are not audited) ● For unincorporated JV or a SPV, each partner in the JV or a SPV must submit its annual financial statements including all items listed above. <p>[Please Note: CIDB-related transactions from R30 000 excluding VAT, financial analysis is compulsory as a contractual requirement. Where they are included, the Enquiry must state them clearly and must state the consequences of failing to meet the contractual requirements.]</p>			

Controlled Disclosure

Anonymously report fraud, corruption at 0800 11 2722/ forensic@eskom.co.za

When downloaded from the document management system, this document is uncontrolled and the responsibility rests with the user to ensure it is in line with the authorized version on the system.

No part of this document may be reproduced in any manner or form by third parties without the written consent of Eskom Holdings SOC Ltd. © copyright Eskom Holdings SOC Ltd. Reg No 2002/015527/30

	Invitation to Tender/ Request for Proposal	Document Identifier	240-114238630	Rev	28	
		Effective Date	07 April 2026			
		Review Date	April 2031			

Reference	Returnable From Suppliers	Returnable required at Tender closing (disqualifiable)*	Returnable required at Tender closing. (Non-disqualifiable)**	Returnable required prior to Contract Award.
	DOCUMENTS REQUIRED UNDER FUNCTIONALITY/TECHINICAL CRITERIA			
Functionality/Technical	See attached technical requirements	√		

Controlled Disclosure

Anonymously report fraud, corruption at 0800 11 2722/ forensic@eskom.co.za

When downloaded from the document management system, this document is uncontrolled and the responsibility rests with the user to ensure it is in line with the authorized version on the system.

No part of this document may be reproduced in any manner or form by third parties without the written consent of Eskom Holdings SOC Ltd. © copyright Eskom Holdings SOC Ltd. Rea No 2002/015527/30

	Invitation to Tender/ Request for Proposal	Document Identifier	240-114238630	Rev	28	
		Effective Date	07 April 2026			
		Review Date	April 2031			

Step 2 - Mandatory tender returnable

Mandatory Technical Requirements

- ECSA Registered Professional Civil Engineer (Structural Engineer)

PR Eng Civil (ECSA Certificate)	0%	100%
---------------------------------	----	------

3.1.2 Functionality – Qualitative Technical Requirements

The functionality assessment constitutes the second phase of the evaluation process, with a total weighting of 100%. The tenderer must achieve a minimum score of 75% across the technical criteria to be considered qualified. These criteria are divided into Eight (8) sub-criteria, each assigned a specific weighting as detailed in the table below.

Table 2: Qualitative Technical Criteria Weightings

Criteria	0	40%	80%	100%
Provide (1-3) traceable evidence of executed work, contracts (with contracts numbers) and/or purchase order (with purchase numbers). (25%) <ul style="list-style-type: none"> • Cooling Tower Structural Repairs • Tunnel repairs for water leaks • Concrete Beams and columns Construction work. 	No evidence provided= 0%	Provided 1 traceable evidence= 40%	Provided 2 traceable evidence= 80%	Provided 3 or More traceable evidence= 100%
Technical Approach & Methodology (20%) Detailed work methodology clearly indicating the how the scope is going to be executed. Acceptable (1 – 4) <ol style="list-style-type: none"> 1. Repair methodology and sequence in details 2. Tools List , Materials and components 3. Detail Risk Assessment and method statement for working at heights on aging infrastructure and corroded structural members. 	Submitted but addressing 1 = 0%	Submitted but addressing 2 points = 40%	Submitted but addressing 3 points = 80%	Submitted and addressing all points = 100%

Controlled Disclosure

Anonymously report fraud, corruption at 0800 11 2722/ forensic@eskom.co.za

When downloaded from the document management system, this document is uncontrolled and the responsibility rests with the user to ensure it is in line with the authorized version on the system.

No part of this document may be reproduced in any manner or form by third parties without the written consent of Eskom Holdings SOC Ltd. © copyright Eskom Holdings SOC Ltd. Reg No 2002/015527/30

	Invitation to Tender/ Request for Proposal	Document Identifier	240-114238630	Rev	28	
		Effective Date	07 April 2026			
		Review Date	April 2031			

<p>4. Resources and Qualification (with their working at height training).</p> <p>To be signed by PR Eng. If not signed, 0% score will be given.</p>				
<p>Company Quality Assurance (10%). Submitted (1-3)</p> <ol style="list-style-type: none"> Detail Quality assurance plan / quality control plan Includes inspections, Tests, Acceptance criteria Company must be ISO 9001 certified). 	Not Compliant 0%	Submitted 1 and Incomplete= 40%	Submitted 2 and Incomplete= 80%	Submitted and Complete= 100%
<p>Safety & Compliance (10%), Submitted (1-3)</p> <ol style="list-style-type: none"> Site-specific safety plan on the Cooling Towers, Regulatory compliance, Safety performance history(LTIs) ISO 45001 certified 	Not Compliant 0%	Submitted 1 and Incomplete= 40%	Submitted 2 and Incomplete= 80%	Submitted and Complete= 100%
<p>Project Schedule & Responsiveness (10%)</p> <p>Submit detailed project schedule (aligning to outage schedules), Includes mobilization, execution and testing.</p>	Not Submitted 0%	Submitted and Incomplete= 40%		Submitted and Complete= 100%
<p>Warranty & Support - Long-term support and accountability after repair. (5%)</p> <ol style="list-style-type: none"> Indicate warranty period and coverage (materials) After-service support, inspection services. Follow-up visits, PM options, inspections offered. 	Not Submitted 0%	Submitted 1 and Incomplete= 40%	Submitted 2 and Incomplete= 80%	Submitted and Complete= 100%
<p>ECSA Candidate Engineer (10%)</p> <p>Submit a CV and BSc / Bing Qualification(s) for a registered ECSA Candidate Civil Engineer with a (3 - 5) years' experience within the Structural Repairs field.</p>	No qualification or Less than 2 year of experience = 0%	Certificate with 3 year of experience = 40%	Certificate with 4 year of experience = 80%	Certificate with 5 year of experience = 100%
<p>Construction Manager (10%)</p> <p>Submit CV and Civil technician with National Diploma Qualification with (3 -5) Years of</p>	No qualification or Less than 2 year of	Certificate with 3 year of	Certificate with 4 year of	Certificate with 5 year of

Controlled Disclosure

Anonymously report fraud, corruption at 0800 11 2722/ forensic@eskom.co.za

When downloaded from the document management system, this document is uncontrolled and the responsibility rests with the user to ensure it is in line with the authorized version on the system.

No part of this document may be reproduced in any manner or form by third parties without the written consent of Eskom Holdings SOC Ltd. © copyright Eskom Holdings SOC Ltd. Reg No 2002/015527/30

	Invitation to Tender/ Request for Proposal	Document Identifier	240-114238630	Rev	28	
		Effective Date	07 April 2026			
		Review Date	April 2031			

experience in the field of reinforced concrete construction (10%).	experience = 0%	experience = 40%	experience = 80%	experience = 100%
Threshold 75%				

Controlled Disclosure

Anonymously report fraud, corruption at 0800 11 2722/ forensic@eskom.co.za

When downloaded from the document management system, this document is uncontrolled and the responsibility rests with the user to ensure it is in line with the authorized version on the system.

No part of this document may be reproduced in any manner or form by third parties without the written consent of Eskom Holdings SOC Ltd. © copyright Eskom Holdings SOC Ltd. Reg No 2002/015527/30

SCOPE OF WORK

GENERAL

- Data books, reviews, reports, and diagrams/drawings shall be submitted to Engineering after the completion of the work. Engineering to forward the data books to Quality Department (Document Control)
- All QCP's to be submitted to Engineering and Quality for approval prior to outage/project or maintenance work commencement.

	SCOPE OF WORK DESCRIPTION / ACTIVITY	PROCEDURE, SPECIFICATION, ENG. REQUIREMENTS / DOCUMENTATION	HOLD POINTS, WITNESS, REPORTS	RESPONSIBLE PARTY
1.1	Occupational Health and Safety	<ul style="list-style-type: none"> • Health and safety file should be approved by Safety risk management department prior to any work commences on site. • All work is to be done in accordance with OHS Act 85 of 1993, Matla plant procedures and Plant Safety Regulations. (240-150642762). • Matla power station SHEQ induction must be done before access to site can be granted. • The contractor should ensure that all employees have acquired the required competency for the task they are performing. • The contractor to ensure compliance to updated legal requirements and other requirements 	Eskom to witness.	Contractor

PUBLIC

When downloaded from the document management system, this document is uncontrolled and the responsibility rests with the user to ensure it is in line with the authorized version on the system. No part of this document may be reproduced without the expressed consent of the copyright holder, Eskom Holdings SOC Ltd, Reg. No 2002/015527/30.

1.2	Environmental Management.	<ul style="list-style-type: none"> • All activities listed in the National Environmental Act 107 of 1998, EIA Regulations as amended, must have environmental AUTHORISATION before commencement of work. • The contractor shall comply with all applicable legal and other requirements. • The polluter pays principle will be applied. • The contractor manager shall ensure compliance with Eskom Matla Environmental procedures to ensure the prevention of pollution (refer: OMOP 4090 and 4402). • The last payment will be processed based on the status of the last housekeeping check sheet (Annexure C: OMOP 4402) of designated area. • EMS file based on ISO14001 will be required. 	Eskom to witness.	Contractor
1.3	Quality Management	<ul style="list-style-type: none"> • The contractor/executioner of work will be responsible for drawing up all QCP documentation and this must be approved by engineering and authorised by the Quality Department before commencing with the work. • Contractors/executioner to adhere to QM 58 and OMOP4497 requirements. • Number of NCR issued can affect your next tendering process. • The QCP shall be signed progressively by the Engineer/Supervisor, Eskom QC Inspector, Contractor QC Inspector, and/or AIA. 	Hold point	Contractor

PUBLIC

When downloaded from the document management system, this document is uncontrolled and the responsibility rests with the user to ensure it is in line with the authorized version on the system. No part of this document may be reproduced without the expressed consent of the copyright holder, Eskom Holdings SOC Ltd, Reg. No 2002/015527/30.

		<ul style="list-style-type: none"> • No procuring of outage items without the approval of scopes by quality • All outage scopes creep and scopes addition should be approved by quality. • No contractor should be in the possession of scopes for execution without the scopes approved by quality. • The contractor is subjected to quality auditing at any point in time during execution of scope 		
1.4	Inputs from other departments			
1.5	Commissioning reference			
	SCOPE OF WORK DESCRIPTION / ACTIVITY	PROCEDURE, SPECIFICATION, ENG. REQUIREMENTS / DOCUMENTATION	HOLD POINTS, WITNESS, REPORTS	RESPONSIBLE PARTY

PUBLIC

When downloaded from the document management system, this document is uncontrolled and the responsibility rests with the user to ensure it is in line with the authorized version on the system. No part of this document may be reproduced without the expressed consent of the copyright holder, Eskom Holdings SOC Ltd, Reg. No 2002/015527/30.

SUMMARY OF THE SCOPE: OPPORTUNITY OUTAGE.

AUXILIARY SCOPE OF WORK:

Figure 1 to 9 Illustrate drawings as well as few photographic images of defect in the plant.

Re-instatement of the collapsed beams and Repair of the broken corbels (CT 1 to 6)

- a) Re-instatement of the collapsed supporting beams for the fill on Collapsed section
- b) Repair the broken corbels on all Cooling towers and any collapsed beams during the Outage

Replacement of Steel Cat ladders and Handrails at CT1 to CT6

- c) Replace the severely corroded cat ladders with a stainless steel inside the towers in total they are Six (6) and 3m each of height per tower.

Expansion Joint at CT1 to CT6 and Ponds repairs on all CTs

- d) Remove and re-instate the expansion joint along in the pond as well as the other joints on the diametric duct in the tower.
- e) Remove delaminated sections and open up the cracks for thorough repairs.

Knee Braces at CT1 to CT6

- f) Re-align the beam connections that have moved from the corbels with a knee brace in all the towers– details of the knee brace provided below/ supplier's design.

Coating of all Columns at CT1 to CT6 and Recasting / re-instatement of all the A frames.

- g) Repair cracks and recoat the main supporting columns in the cooling towers.
- h) Conduct housekeeping and clean the area.
- i) Demolish / re-instate and recast the A-Frame at CT1 to CT6

Handrails

- j) Replace the current damaged handrails at CT1 TO CT6.

The Launder channels

- k) Re-instate the walls of all the launders feeding the towers and replace the joint sealant.

PUBLIC

When downloaded from the document management system, this document is uncontrolled and the responsibility rests with the user to ensure it is in line with the authorized version on the system. No part of this document may be reproduced without the expressed consent of the copyright holder, Eskom Holdings SOC Ltd, Reg. No 2002/015527/30.

Screen Washing Bay

- l) The contractor shall repair the channels at the screen washing bay and the top walls and recast all the damage top wall of the screen washing bay.

Additional Requirements

- Provide continues pumping/draining of the pond and the diametric ducts.
- Provide product data sheet.
- QCPs prior commencement of the works.
- Detail Method statement signed supported by Pr Civil Engineer for 3.1.1 to 3.1. 8
- The team to conduct the housekeeping prior to plant handover to commissioning.
- Work must be conducted in line with the following procedures/standards and regulations
 - Occupation Health and Safety Act No 181 of 1993
 - 36-681 (Rev 2) Generation Plant Safety Regulations
 - 39-98 Rev 1 Safe Use of Lifting Machines

4. GENERAL ARRANGEMENT AND LOCATION DRAWINGS

No	DRAWING NUMBER	TITLE

5. APPLICABLE CORPORATE / GENERATION / INTERNATIONAL GUIDELINES AND STANDARDS

No	REFERENCE NUMBER	DOCUMENT TITLE
1	36-681	Generation Plant Safety Regulations
2		Occupation Health and Safety Act 1993

5.1.1 APPLICABLE MATLA POWER STATION STANDARDS AND PROCEDURES.

No	REFERENCE NUMBER	DOCUMENT TITLE
1	240-72261425	Outage Philosophy for Matla Power Station

GENERAL CONSIDERATIONS

6.1 PRE-REQUISITES / PRE-CONDITIONS

PUBLIC

When downloaded from the document management system, this document is uncontrolled and the responsibility rests with the user to ensure it is in line with the authorized version on the system. No part of this document may be reproduced without the expressed consent of the copyright holder, Eskom Holdings SOC Ltd, Reg. No 2002/015527/30.

ACTIVITIES	SPECIFICATIONS
Data books, reviews, reports and diagrams / drawings shall be submitted to Engineering 21 days after the completion of the work. Engineering to forward all data books to the Quality Department (Documentation Control).	WI 4418
All QCP's to be submitted to Engineering and Quality for approval prior to the outage / project commencement.	

6.2 SAFETY	
ACTIVITIES	SPECIFICATIONS
All work is to be done in accordance with Matla Plant Procedures and Safety Regulations.	GGR 0992
Matla Power Station induction must be done before any work commences.	
A permit to work must be in place before any work commences.	36-681 (Rev 2) Generation Plant Safety Regulation
The worker's register must be completed and daily risk assessments conducted before any work commences.	

6.3 ENVIRONMENT	
ACTIVITIES	SPECIFICATIONS
All activities listed in the National Environmental Act 107 of 1998, EIA Regulations as amended, must have environmental AUTHORIZATION before the work can commence.	
The contractor shall comply with all applicable legal and other requirements.	
The polluter pays principle shall be applied.	
The contractor's manager shall ensure compliance to Eskom Matla Environmental Procedures to ensure the prevention of pollution.	OMOP 4090 and OMOP 4402
The last payment will be processed based on the status of the last housekeeping check sheet of the designated work area	OMOP 4402
EMS File based on ISO 14001 will be required.	

PUBLIC

When downloaded from the document management system, this document is uncontrolled and the responsibility rests with the user to ensure it is in line with the authorized version on the system. No part of this document may be reproduced without the expressed consent of the copyright holder, Eskom Holdings SOC Ltd, Reg. No 2002/015527/30.

6.4 QUALITY	
ACTIVITIES	SPECIFICATIONS
<p>Process Quality Process/Procedure (PQP/QCP)</p> <p>The Contractor / Executioner of the work will be responsible for drawing up all QCP documentation, which must be approved by Engineering and Authorized by the Quality Department prior to commencing with the work.</p>	
<p>Hold and witness points</p> <p>H&W points that form part of the QCP and have been approved prior to the start date, shall not be by-passed under any circumstances without the written concession of an authorised member of the Engineering Department. It is the Contractors responsibility to inform the Plant Engineer or his representative at the daily progress meetings when an activity will be ready for QC.</p>	

The Contractor / Executioner shall adhere to QM58 and OMOP4497 requirements	QM58 and OMOP4497
The number of NCR's issued can affect your next tendering process.	
The QCP shall be signed progressively by the Engineer / Supervisor, Eskom QC Inspector, Contractor QC Inspector and/or AIA.	

6.4 QUALITY	
ACTIVITIES	SPECIFICATIONS
No procuring of outage items without the approval of Scopes of Work by the Quality Department.	
All outage scope creep and scope addition shall be approved by the Quality Department.	
No Contractor shall be in the possession of Scopes of Work for execution, without prior approval as indicated on the cover page of this document template.	
The contractor is subjected to quality auditing at any point in time during the execution of the Scope of Work.	

PUBLIC

When downloaded from the document management system, this document is uncontrolled and the responsibility rests with the user to ensure it is in line with the authorized version on the system. No part of this document may be reproduced without the expressed consent of the copyright holder, Eskom Holdings SOC Ltd, Reg. No 2002/015527/30.

6.5 OTHER REQUIREMENTS	
ACTIVITIES	SPECIFICATIONS
The importance of correct equipment spares and procedures should be included in structured toolbox talk sessions with all contractors.	
<p>Spares It should be kept in mind that lead time of outside plant spares required during major overhauls can be as much as 12 months. Therefore all the spares required will be ordered in time. Spares ordered and used will be reported by always quoting the Eskom stock number (if applicable) as well as the Group and item number from the spares manuals.</p>	
<p>Documentation Full service reports must be compiled and submitted to both Engineering and the Matla documentation centre for safe keeping and approval 21 days after unit is synchronised on load</p>	WI 4418
<p>Equipment Lifting equipment: An up to date test certificate will be available for all lifting equipment that will be used.</p> <p>Measuring equipment: An up to date calibration certificate must be available for all measuring equipment that will be used.</p> <p>Special tools will be serviced before the outage, will be available on site and will be on good working condition. A list of all special tools must be compiled before the outage and submitted to Engineering. The special tools must be readily available for inspection by QC and Engineering.</p>	
<p>Use of SAP PM to record history and costs SAP PM will be used to record history of work done and the related costs to at least the second level of headings as listed in this document.</p>	

6.6 EXISTING DEFECTS	
ACTIVITIES	SPECIFICATIONS
A list of all defects loaded before the submission of this SOW should be attached in Section 10.	

PUBLIC

When downloaded from the document management system, this document is uncontrolled and the responsibility rests with the user to ensure it is in line with the authorized version on the system. No part of this document may be reproduced without the expressed consent of the copyright holder, Eskom Holdings SOC Ltd, Reg. No 2002/015527/30.

1.7 BUDGET BILLS OF MATERIAL

NOTE: SOW OF WORK VARIATIONS WILL BE ISSUED ONLY IF REFURBISHMENT OR REPLACEMENT COMPONENTS EXCEED BUDGET, OTHERWISE CUTTING INSTRUCTIONS WILL BE USED TO COMMUNICATE WHICH COMPONENTS MUST BE REPAIRED, REPLACED OR REFURBISHED.

Area / structure	SI Units	Quantity
Pond Containment		
Steel (reinforcement)	Kg	2500
Concrete	m3	60
Grout	Kg	1000
Waterproofing liquid	L	12000
Coating on Tower columns		
Euclid Vandex Super Coating	l	50000
Cleaning of existing coat	Sum	Sum
Internal Beams and corbels		
Concrete (pumped)	m3	60
Steel	kg	5000
Grout	kg	3000
Diametric Duct		
Steel (rebar's)	kg	6000
Gunit concrete	m3	720
Bolts and Nuts for all plates and handrails	kg	150
Platforms and Cat Ladders		
Handrails		sum
Wind Deflectors		
Concrete	M3	200
Steel	kg	5000
Concrete panels (New design – 600panels)	sum	sum
Cat Ladders and Platforms		
Cat Ladder (stainless steel)	m	120
Handrails	m	300
Pump/Draining of Diametric Duct and Ponds (Continuous)	sum	sum

PUBLIC

When downloaded from the document management system, this document is uncontrolled and the responsibility rests with the user to ensure it is in line with the authorized version on the system. No part of this document may be reproduced without the expressed consent of the copyright holder, Eskom Holdings SOC Ltd, Reg. No 2002/015527/30.

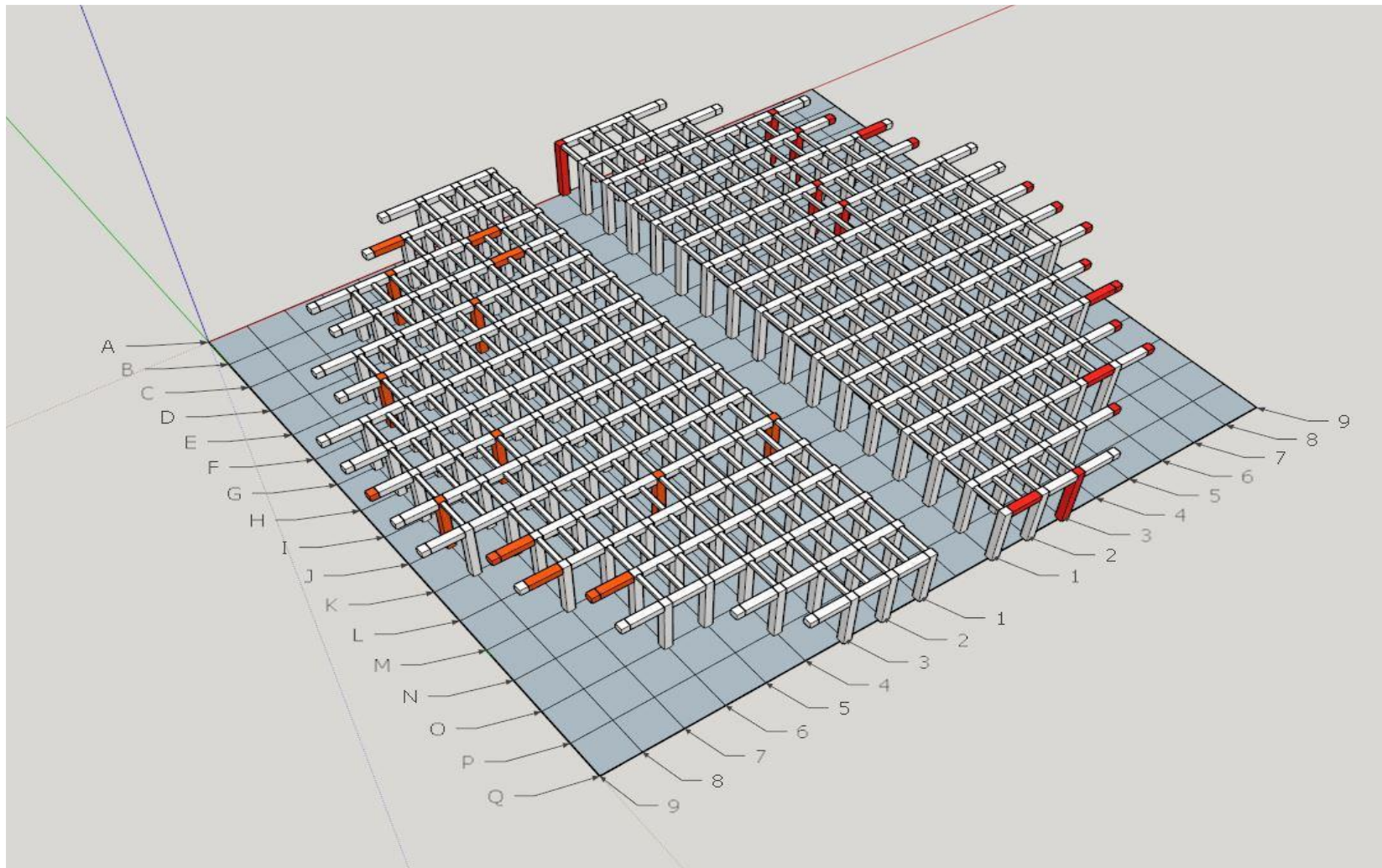

Figure 1: Tower internal arrangement

Evidence of damages in the Cooling Towers.

PUBLIC

When downloaded from the document management system, this document is uncontrolled and the responsibility rests with the user to ensure it is in line with the authorized version on the system. No part of this document may be reproduced without the expressed consent of the copyright holder, Eskom Holdings SOC Ltd, Reg. No 2002/015527/30.

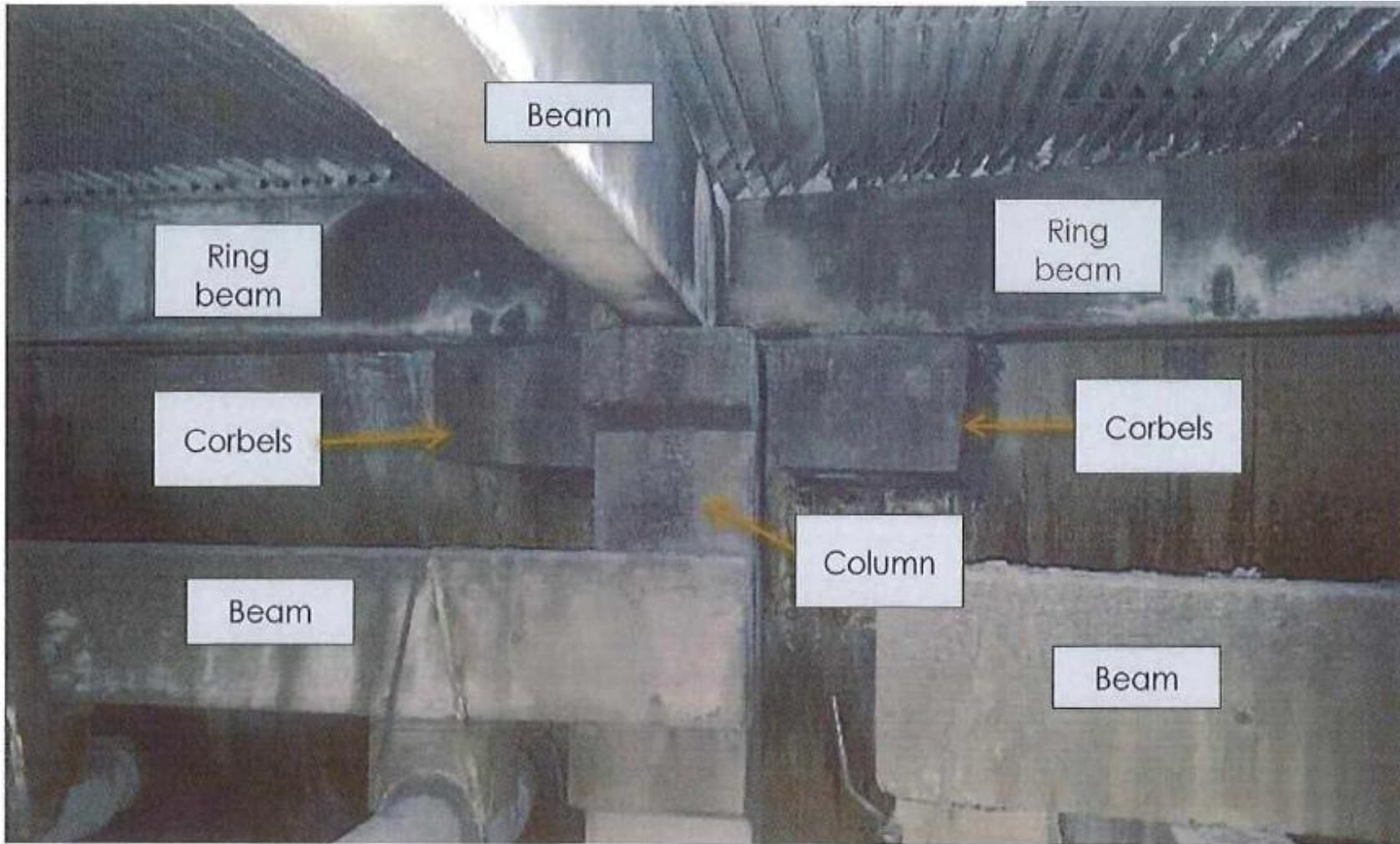

Figure 2: Basic labelling of the Structural components.

Columns, beams, Ring beam and corbel connections.

PUBLIC

When downloaded from the document management system, this document is uncontrolled and the responsibility rests with the user to ensure it is in line with the authorized version on the system. No part of this document may be reproduced without the expressed consent of the copyright holder, Eskom Holdings SOC Ltd, Reg. No 2002/015527/30.

The columns, ring beams and corbels generally have a low degree of damage, but there are a few beam connections that have a medium degree of damage with misalignment and cracking due to thermal movement. These beam connections need to be repaired or sealed per the concrete repair method (Please refer to method stated below. Knee braces (see below) should be installed at all affected column beam connections. The knee brace will tie the columns to the beams and prevent any future movement.



Figure 3: Cracking at beam edge



Figure 4: Ring Beam Cracking

PUBLIC

When downloaded from the document management system, this document is uncontrolled and the responsibility rests with the user to ensure it is in line with the authorized version on the system. No part of this document may be reproduced without the expressed consent of the copyright holder, Eskom Holdings SOC Ltd, Reg. No 2002/015527/30.



Figure 5: Cracking and spalling at beam corbel connection



Figure 6: Sulphate Attack

PUBLIC

When downloaded from the document management system, this document is uncontrolled and the responsibility rests with the user to ensure it is in line with the authorized version on the system. No part of this document may be reproduced without the expressed consent of the copyright holder, Eskom Holdings SOC Ltd, Reg. No 2002/015527/30.



Figure 7: Pond internal walls cracking.

Knee brace detail

The knee braces are to be installed at all affected column beam connection. The knee brace will tie the columns to the beams and prevent any future movement. The knee brace consists of 150x150x10 angle 300mm long with 4 M16 grade 8.8 stainless steel chemical anchors and a 10mm stiffener between the bolts.

PUBLIC

When downloaded from the document management system, this document is uncontrolled and the responsibility rests with the user to ensure it is in line with the authorized version on the system. No part of this document may be reproduced without the expressed consent of the copyright holder, Eskom Holdings SOC Ltd, Reg. No 2002/015527/30.

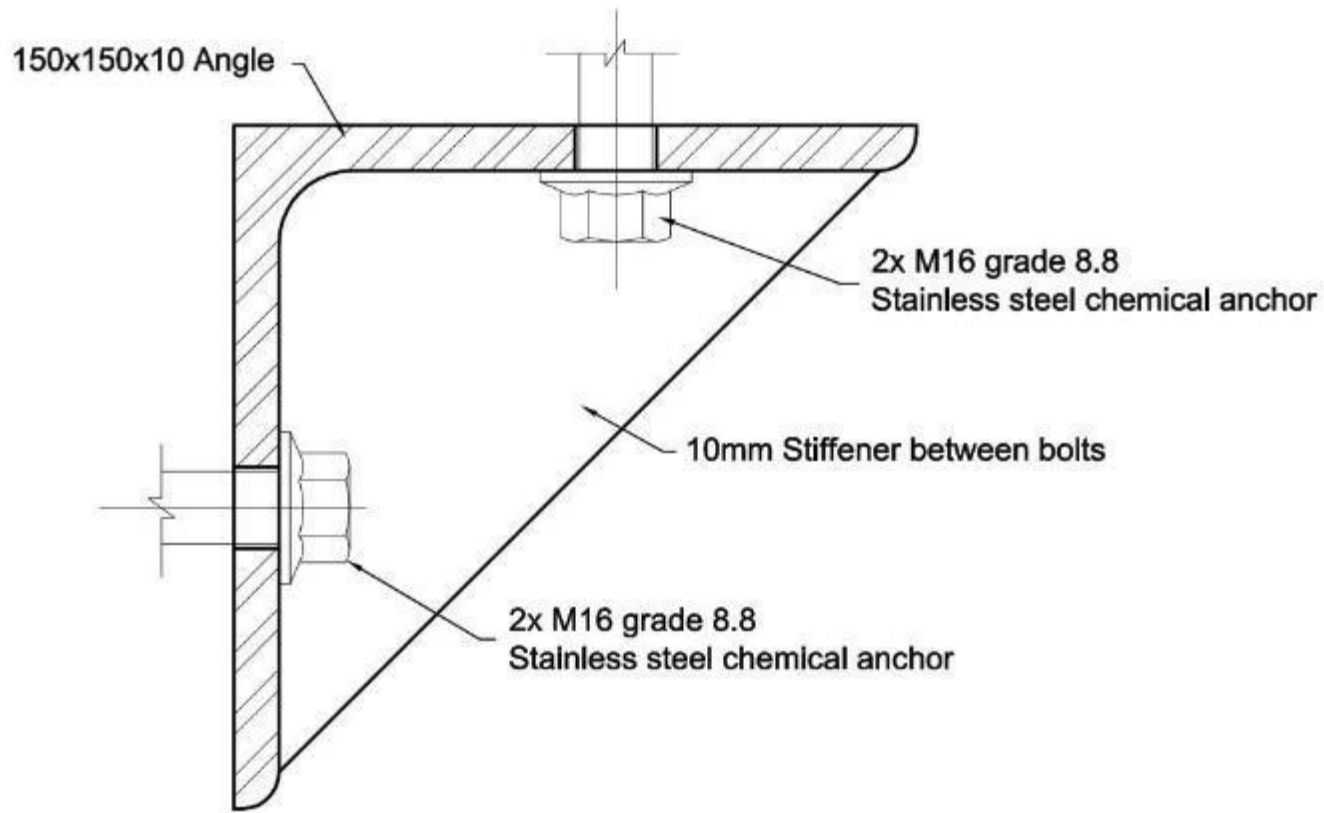

Figure 8: Knee Brace

PUBLIC

When downloaded from the document management system, this document is uncontrolled and the responsibility rests with the user to ensure it is in line with the authorized version on the system. No part of this document may be reproduced without the expressed consent of the copyright holder, Eskom Holdings SOC Ltd, Reg. No 2002/015527/30.

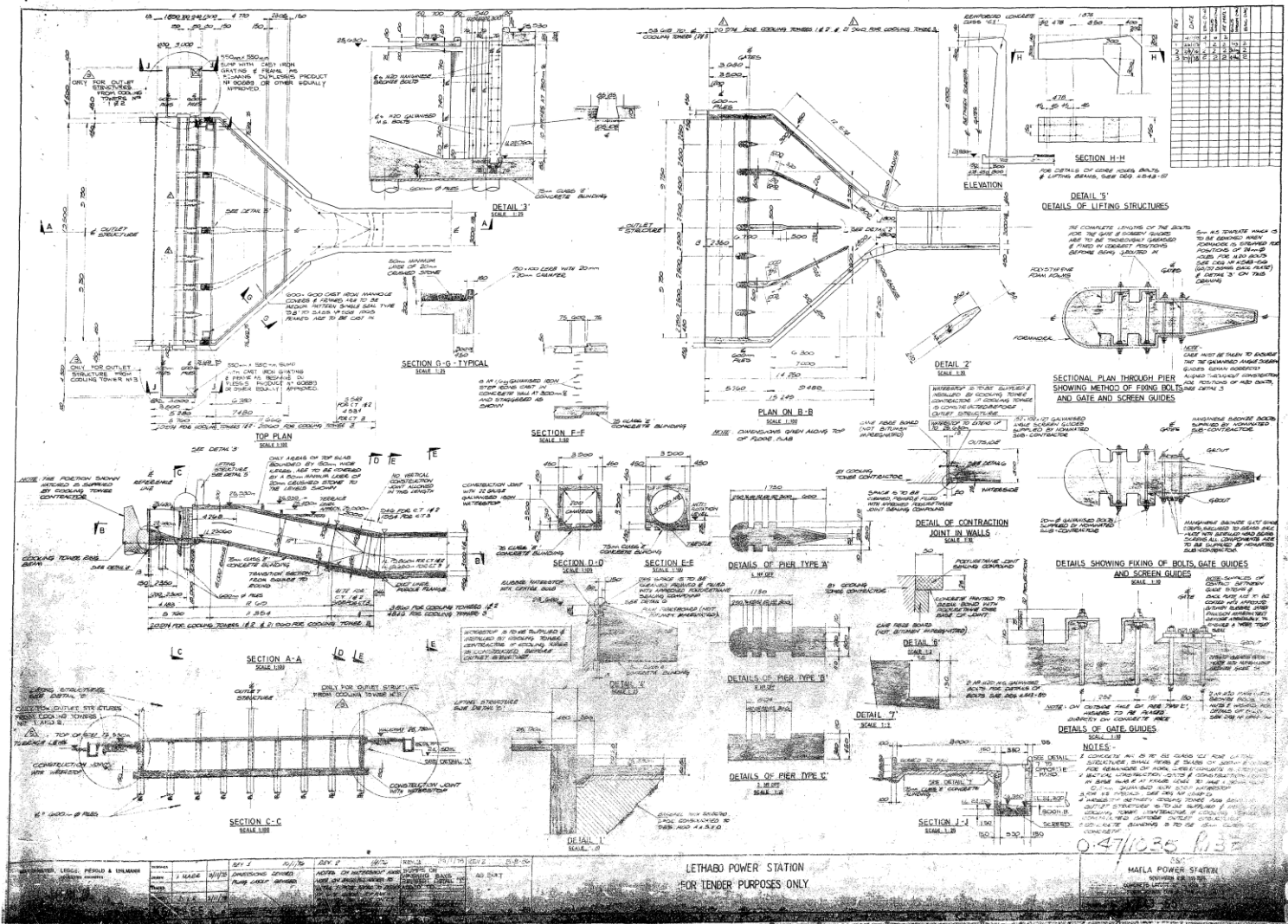

Figure 9: Diametric duct drawing

PUBLIC

When downloaded from the document management system, this document is uncontrolled and the responsibility rests with the user to ensure it is in line with the authorized version on the system. No part of this document may be reproduced without the expressed consent of the copyright holder, Eskom Holdings SOC Ltd, Reg. No 2002/015527/30.

CONTRACTUAL OBLIGATIONS (Non-weighted criterion)

In terms of the PPPFA, the application of objective criteria may be a valid and justifiable reason why a tender is not awarded to the highest scoring / highest ranked supplier, after application of the 80:20 preference points system. Objective criteria will generally be applied after evaluation and are generally the criteria / conditions specifically linked to contract award (viz., legal compliance, adherence to contract terms and conditions. The requirements for the objective criteria do not form part of the above Part A and Part B; however, they will be required from the recommended tenderer/s to submit them before the contract award.

STEP 4: OBJECTIVE CRITERIA

Price and Preference Analysis

- 80/90% Price
- 20/10% BBEE

Price Evaluation (80/90 points)

Adjudication Criteria	Points
Price Evaluation $P_s = 80 \left(1 - \frac{P_t - P_{min}}{P_{min}} \right)$	80

Where

- P_s = Points scored for comparative price of tender under consideration
 P_t = Comparative price of tender under consideration
 P_{min} = Comparative price of lowest acceptable tender

B-BBEE Evaluation (20/10 Points)

Tenderers are required to submit a valid B-BBEE Status Level Verification Certificates together with their tenders to substantiate the B-BBEE claims.

PUBLIC

When downloaded from the document management system, this document is uncontrolled and the responsibility rests with the user to ensure it is in line with the authorized version on the system. No part of this document may be reproduced without the expressed consent of the copyright holder, Eskom Holdings SOC Ltd, Reg. No 2002/015527/30.

Tenderers, who do not submit B-BBEE Status Level Verification Certificate or non-compliant contributors to B-BBEE will not qualify for preference points, however, will not be disqualified from the tender process. Such tenderer will score out of 80/90 points for price and 0 points out of 10 for B-BBEE.

Points awarded to a tenderer for attaining the B-BBEE Status Level of contribution in accordance with the table below:

Financial Evaluation

An analysis of the tenderers financial statements will be conducted for the purpose of establishing the tenderers financial viability and ability to meet all its contractual obligations for the duration of the contract, should the tenderer be awarded the contract?

PUBLIC

When downloaded from the document management system, this document is uncontrolled and the responsibility rests with the user to ensure it is in line with the authorized version on the system. No part of this document may be reproduced without the expressed consent of the copyright holder, Eskom Holdings SOC Ltd, Reg. No 2002/015527/30.

Price Schedule

Provision of Cooling Towers 1 – 6 Internal Civil Refurbishment during planned (GO and MGO) at Matla Power Station for a period of 5 years as an when required basis

ITEM NO.	DESCRIPTION	UNIT	QUANTITY	RATE	AMOUNT
	PRELIMINARIES AND GENERAL				
	SCHEDULED FIXED-CHARGE AND VALUE-RELATED ITEMS:				
	SCHEDULED FIXED-CHARGE ITEMS:				
1.0	Contractual requirements.	Sum	1		
2.0	Site Establishment (offices, storage, furniture etc)	Sum	1		
3.0	Ablution and uterine facilities	Sum	1		
4.0	Site Plant	Sum	1		
5.0	Site De- Establishment	Sum	1		
6.0	Safety Reequipments (Medical, PPE etc)	Sum	1		
7.0	Quality Requirements	Sum	1		
8.0	Environmental Requirements	Sum	1		
	SCHEDULED TIME - RELATED ITEMS:				
1.0	Contractual requirements.	Monthly	6		
2.0	Site hire (offices, storage, furniture etc)	Monthly	60		
3.0	Ablution and uterine facilities	Monthly	60		
4.0	Accommodation and Meals	Monthly	6		
5.0	Transport Provision	Day	185		
6.0	Site Plant	Monthly	6		

PUBLIC

When downloaded from the document management system, this document is uncontrolled and the responsibility rests with the user to ensure it is in line with the authorized version on the system. No part of this document may be reproduced without the expressed consent of the copyright holder, Eskom Holdings SOC Ltd, Reg. No 2002/015527/30.

7.0	Safety Reequipments (Medical, PPE etc)	Monthly	6		
8.0	Quality Requirements	Monthly	6		
9.0	Environmental Requirements	Monthly	6		
10.0	Supervision	Monthly	6		
	Sub Total				
	AREA/ STRUCTURE				
1.0	Pond Containment				
	Steel (reinforcement)	kg	2500		
	Concrete (strength)	m3	20		
	Grout	kg	1000		
	Waterproofing	l	12000		
	Formwork	m2	100		
2.0	Coating on Tower collum				
	Euclid Vandex super Coating	l	50000		
	Cleaning of existing coat	sum	1		
3.0	Internal Beam and Corbels				
	Concrete (pumped)	m3	60		
	Steel	kg	5000		
	Grout	kg	3000		
	Formwork	m2	100		
4.0	Diametric Duct				
	Steel (rebar')	kg	6000		

PUBLIC

When downloaded from the document management system, this document is uncontrolled and the responsibility rests with the user to ensure it is in line with the authorized version on the system. No part of this document may be reproduced without the expressed consent of the copyright holder, Eskom Holdings SOC Ltd, Reg. No 2002/015527/30.

	Gunith concrete	m3	750		
	Bolts and Nuts for all plates and handrails	kg	150		
5.0	Wind Deflectors				
	Concrete	m3	200		
	Steel	kg	2500		
	Formwork	m2	100		
	A panel				
	Removal of 400 x 80mm thick precast concrete panels	m	2592		
	Break and remove reinforced concrete	m3	104		
	Rough formwork to rectangular columns	m2	302		
	30mpa concrete to column	m3	242		
	Install precast concrete panels	m	2592		
6.0	Cat Ladders and Platforms				
	Cat Ladders (stainless steel)	m3	120		
	Handrails	m3	300		
	Pump/Draining of Diametric Duct and Pond for all six towers (Provisional Sum)	sum	1		
	Sub Total				
	TOTAL AMOUNT				

PUBLIC

When downloaded from the document management system, this document is uncontrolled and the responsibility rests with the user to ensure it is in line with the authorized version on the system. No part of this document may be reproduced without the expressed consent of the copyright holder, Eskom Holdings SOC Ltd, Reg. No 2002/015527/30.

Safety Requirements:

Health and Safety requirements

Contractual requirements mean the suppliers will submit the tender returnable during the tender close-out. The evaluation will take place once the mandatory and Functionality evaluation have been completed. The service provider will be given only ONE opportunity to submit the outstanding documents within 7 working days. Failure to submit the outstanding documents within the stipulated time; may result in the tenderer being regarded as non-responsive and ineligible for contract award. These OHS requirements will form part of the procurement process and must be complied with prior to signing the contract. The Service provider shall comply with the respective Matla power station Safety file requirements to gain access to site. No work shall commence until the Safety file is approved by the respective site's Contract custodian together with the OHS professional.

Annexure B
Is the acknowledgement of Eskom's OHS legal and other requirements form signed and submitted by the tenderer?
Health and Safety Plan (must address the project /scope of work OHS risk(s) and aligned with the health and safety specification or requirements)
Costing for Health and Safety management
Has the tenderer submitted detailed costing for OHS (the cost should be broken down not provided as a lump sum).
<ul style="list-style-type: none">• The costing must be based on the overall scope of work/service to be performed.• The scope of work and the risk assessment may serve as a guideline.
OHS Baseline Risk Assessment (BRA)
Identification, assessment and management of OHS risks related to the scope of work. The methodology used for the risk assessment must be provided together with the BRA
Valid Letter of Good Standing (COIDA or equivalent)
Occupational Health & Safety policy signed by CEO
The submitted policy must comply to OHS Act Section 7 and Clause 5.2 of ISO 45001
A record of health and safety statistics for the past three years
Provide incidents statistics for the company for three financial years. Incidents to be included in the statistics are medicals, lost time injuries, Occupational diseases and fatalities.

ENVIRONMENTAL OBJECTIVE REQUIREMENTS

Category B: Terms and Service contract

- Sign Contractors commitment and indemnity letter.
- Environmental Contractors Assessment form
- SHEQ /Environmental Policy
- Aspects and Impacts Register

PUBLIC

When downloaded from the document management system, this document is uncontrolled and the responsibility rests with the user to ensure it is in line with the authorized version on the system. No part of this document may be reproduced without the expressed consent of the copyright holder, Eskom Holdings SOC Ltd, Reg. No 2002/015527/30.

- Objectives and Targets
- Emergency preparedness Procedure or work instruction
- Non-Conformance, Corrective action, and preventive action
- Roles and Responsibilities of the employees (also stating their roles in terms of environmental management)
- Waste Management plan with the following:
 - ✓ Register of possible waste to be generated by the project.
 - ✓ Waste segregation
 - ✓ Waste minimization
 - ✓ Records of waste quantities disposed (Template)
 - ✓ Legislation requirements
- Environmental management plan
- All method statements, as a minimum addressing the items as per scope of work, Aspects/Impacts register
- CV and Proof of Qualifications of the contractor’s environmental officer or SHE officer who will be responsible for the implementation of the environmental requirements for the contract.
- Proof of training (certificates) of persons performing activities that could have significant impact on the environment.

Environmental Costs

QUALITY REQUIREMENTS:

SECTION A (TENDER)	ENQUIRY/ CONTRACT No:		
	ENQUIRY/ CONTRACT DESCRIPTION	Internal Cooling tower 1-6 civil refurbishment	
	CLAUSES OF 240-105658000 SPECIFICATION	CLAUSE DESCRIPTION	INDICATE WITH AN (X) AS APPLICABLE OR (-) IF NOT APPLICABLE
SECTION B (ESKOM)	CLAUSE 3	PRE-CONTRACT AWARD QUALITY REQUIREMENTS	X
	CLAUSE 4	(*Select Only Applicable Category). NB: Not more than one category must be selected. Also indicate whether site assessment is applicable.	
		Category 1 (refer to clause 3.5.2 of 240-105658000)	X
		Category 2 (refer to clause 3.5.3 of 240-105658000)	-
		Category 3 (refer to clause 3.5.4 of 240-105658000)	-
		Category 4 (refer to clause 3.5.5 of 240-105658000)	-
	Main Supplier and Sub-supplier Capability and Capacity Assessment (refer to clause 3.6 of 240-105658000)	-	
CLAUSE 5	POST-CONTRACT AWARD		

PUBLIC

When downloaded from the document management system, this document is uncontrolled and the responsibility rests with the user to ensure it is in line with the authorized version on the system. No part of this document may be reproduced without the expressed consent of the copyright holder, Eskom Holdings SOC Ltd, Reg. No 2002/015527/30.

		Contract Execution (refer to clause 3.7.1 of 240-105658000)				X	
		Supplier Quality Performance Monitoring Phase (refer to clause 3.7.2 of 240-105658000)				X	
	CLAUSE 6	STANDARD CONDITIONS					
			Eskom Rights of Access (refer to clause 3.8.1 of 240-105658000)				X
			Eskom Rights to Information (refer to clause 3.8.2 of 240-105658000)				X
			Preservation (refer to clause 3.8.3 of 240-105658000)				X
			Quality Audits Related Conditions (refer to clause 3.8.4 of 240-105658000)				X
			Management of Nonconformities and Nonconforming Outputs Identified by Eskom (refer to clause 3.8.5 of 240-105658000)				X
			SPECIAL PROCESSES (REFER TO CLAUSE 3.8.6 OF 240-105658000)				X
CLAUSES OF ISO 9001 STANDARD	ISO 9001 STANDARD CLAUSE DESCRIPTION	INDICATE WITH AN (X) AS APPLICABLE OR (-) IF NOT APPLICABLE	QUALITY PRINCIPLES	ISO 9001 STANDARD PRINCIPAL DESCRIPTION	INDICATE WITH AN (X) AS APPLICABLE OR (-) IF NOT APPLICABLE		
SECTION C (ESKOM)	CLAUSE 4	Context of the Organisation	X	PRINCIPLE 1	Customer focus	X	
	CLAUSE 5	Leadership	X	PRINCIPLE 2	Leadership	X	
	CLAUSE 6	Planning	X	PRINCIPLE 3	Engagement of people	X	
	CLAUSE 7	Support	X	PRINCIPLE 4	Process approach	X	
	CLAUSE 8	Operation	X	PRINCIPLE 5	Improvement	X	
	CLAUSE 9	Performance Evaluations	X	PRINCIPLE 6	Evidence based decision making	X	
	CLAUSE 10	Improvement	X	PRINCIPLE 7	Relationship Management	X	
SECTION D (ESKOM)	ESKOM'S QUALITY REPRESENTATIVE	NAME		DESIGNATION	DATE	SIGNATURE	
				Officer QA	21 January 2026		
SECTION E (TENDERER)	TENDERER'S QUALITY REPRESENTATIVE	NAME		DESIGNATION	DATE	SIGNATURE	

PUBLIC

When downloaded from the document management system, this document is uncontrolled and the responsibility rests with the user to ensure it is in line with the authorized version on the system. No part of this document may be reproduced without the expressed consent of the copyright holder, Eskom Holdings SOC Ltd, Reg. No 2002/015527/30.

Category 1 : Quality Requirements	Deliverables to be evaluated indicator = 1	
SECTION A: Quality Management System Requirements ISO 9001 (Option 1) Valid certification of Quality Management System by an ISO accredited body		
		Apply =1
A.1 Product / Service Scoping on ISO 9001 certificate is defined and relevant		1
A.2 Certificate by Approved and Authorized certification authority		1
A.3 Certification Authority has Recognized International Accreditation		1
A.4 Validity (expiry date) of certificate		1
Section A Score Option 1		4
SECTION B: Evidence of QMS in operation (Tender Quality Requirements -Ref 240-105658000)		
		Apply =1
B.1 Documented information for defined roles, responsibilities and authorities - Organization chart and Responsibility matrix (must include but not limited to quality management function/role) (Clause 5.3 of ISO 9001:2015)		1
B.2 Documented information for Control of Externally Provided Processes, Products and Services - Must include criteria for evaluation, selection, monitoring of performance, and re-evaluation of external providers (Clause 8.4 of ISO 9001:2015)		1
B.3 Latest copy of an internal management system audit report (with Nonconformity, Correction and/ or Corrective Action Reports) - Report must include but not limited to Objective, Scope, Criteria and outcomes of the audit. (Clause 9.2 of ISO 9001:2015)		1
B.4 Latest copy of a certification management system audit report not older than 12 months (with Nonconformity, Correction and/ or Corrective Action Reports)		1
B.5 Records of Management Review meetings (minutes, attendance registers etc.)		1
Section B Score		5

PUBLIC

When downloaded from the document management system, this document is uncontrolled and the responsibility rests with the user to ensure it is in line with the authorized version on the system. No part of this document may be reproduced without the expressed consent of the copyright holder, Eskom Holdings SOC Ltd, Reg. No 2002/015527/30.

SECTION C: Contract Quality Plan Requirements (Ref 240-105658000 and 240-109253698).	
Draft Contract Quality Plan specific to the scope of work as described in the tender documents (Ref ISO 10005)	
	Apply (Yes=1)
NB! Draft Contract/Project Quality Plan has important QA deliverables	1
Section C Score	1
SECTION D: Quality Control Plan Requirements (Ref 240-105658000 or 240-109253302)	
QCP /Checklist/ ITP (Quality Control Plans) as per Scope of Works (Ref ISO 10005)	
	Apply = 1
NB! Draft/ Example of an Inspection and Test Plan (ITP) or Quality Control Plan (QCP) on similar and/ or previous work done	1
Section D Score	1
SECTION E: User defined additional Requirements & miscellaneous (Ref 240-105658000)	
Customer specific requirements & other standards and required can be listed and evaluated here	
	Apply (Yes=1)
E.1 Form A is completed and signed.	1
E.2 Add other requirements (if applicable) as per the scope of work and/ or specification	1
Section E Score	2
NAME OF ESKOM REPPRESENTATIVE	Officer QA
DATE ISSUED	21-Jan-26
PROJECT: TENDER TITLE	Internal cooling tower 1-6 Civil structural refurbishment
SIGNATURE	

PUBLIC

When downloaded from the document management system, this document is uncontrolled and the responsibility rests with the user to ensure it is in line with the authorized version on the system. No part of this document may be reproduced without the expressed consent of the copyright holder, Eskom Holdings SOC Ltd, Reg. No 2002/015527/30.

PUBLIC

When downloaded from the document management system, this document is uncontrolled and the responsibility rests with the user to ensure it is in line with the authorized version on the system. No part of this document may be reproduced without the expressed consent of the copyright holder, Eskom Holdings SOC Ltd, Reg. No 2002/015527/30.

SDL&I REQUIREMENTS:

Description/ Scope of Work	Statutory Cooling Tower 1 to 6 Internal structural repairs
Duration of the Project	60 months

Section 1: Specific Goals

A maximum of 10/20 points may be awarded to a tenderer for the specific goal specified for the tender. The points scored for the specific goal must be added to the points scored for price and the total must be rounded off to the nearest two decimal places. Subject to section 2(1)(f) of the Preferential Procurement Policy Framework Act, the contract must be awarded to the tenderer scoring the highest points.

B-BBEE Status Level of Contributor	Number of points (90/10 system)	Number of points (80/20 system)
1	10	20
2	9	18
3	6	14
4	5	12
5	4	8
6	3	6
7	2	4
8	1	2
Non-compliant contributor	0	0

NB: The following documents are required to claim preference points,

- Valid B-BBEE certificate issued by a SANAS accredited verification agency / sworn affidavit / CIPS affidavit
- Proof of ownership / shareholding (preferably CIPC documentation) inclusive of shareholding breakdown
- Certified ID copies of shareholder(s)
- Proof of Disability (where applicable)
- In a case of a trust, consortium or joint venture (including incorporated consortia and joint ventures), a consolidated B-BBEE status level verification certificate.
- Deponent electrical signature will not be accepted

Tenderer failing to provide documentation for the allocation of preference points will not be disqualified, but'

- May only score point out of 90/80 for price
- Scores 0 points out of 10/20 for specific goals

Section 2: SDL&I Objectives in line with Reconstruction and Development Programme (RDP) Goals

PUBLIC

When downloaded from the document management system, this document is uncontrolled and the responsibility rests with the user to ensure it is in line with the authorized version on the system. No part of this document may be reproduced without the expressed consent of the copyright holder, Eskom Holdings SOC Ltd, Reg. No 2002/015527/30.

Tenderers who complete and submit the objectives as required, but who do not meet Eskom's targets, will not be disqualified. SDL&I objectives do not form part of scoring but commitments will form part of contractual obligations

1. Transformation – BBEE Improvement or Retention Plan

Transformation remains an area of focus, where Eskom continuously strives to align itself with national transformation imperatives to unlock growth, drive industrialization, create employment and contribute to skills development.

Eskom encourages its suppliers to constantly strive to improve their B-BBEE rating. Whereas Tenderer/s will be allocated points in terms of a preference point system based on specific goals, Eskom also requests that tenderer/s submits their B-BBEE improvement or retention plan within 30 days of signing the contract.

Tenderer/s are therefore requested to indicate the extent to which they will maintain (only if the respondent is a Level 1) or may improve/maintain their B-BBEE status over the contract period if their B-BBEE status is level 2 or 3. Tenderer/s with a B-BBEE status level 4 at the time of contract award, shall migrate and achieve as a non-negotiable a milestone of B-BBEE Level 3 by the end of the first year of the contract and thereafter improve their B-BBEE status level or migrate by one level higher.

Tenderer/s with a B-BBEE recognition status of Level 5 to Level 8 or non-compliant at the time of contract award, shall migrate and achieve as a non-negotiable a milestone of Level 4 by the end of the first year of the contract and thereafter improve at least one B-BBEE Level higher of each year from the second year of the contract.

Tenderer/s are requested to submit their B-BBEE Improvement Plan as an essential document within 30 days of signing the contract.

NB: A valid B-BBEE certificate or Sworn Affidavit is a condition for contract award, if your company's annual Total Revenue is R10 Million or less you qualify as an Exempted Micro Enterprise therefore you can submit Sworn Affidavit. If your annual Total Revenue is R50 Million or less, you qualify as Qualifying Small Enterprise and must comply with all of the elements of QSE score card relevant to your sector unless an entity is at least 51% Black owned you are required to obtain a Sworn affidavit. If your Annual Total Revenue is above R50m you need to submit a Valid B-BBEE certificate.

2. Local Procurement Content

"Local Procurement Content" refers to value added in South Africa by South African resources. Where a single contract involves a combination of local and imported goods and/or services, the

PUBLIC

When downloaded from the document management system, this document is uncontrolled and the responsibility rests with the user to ensure it is in line with the authorized version on the system. No part of this document may be reproduced without the expressed consent of the copyright holder, Eskom Holdings SOC Ltd, Reg. No 2002/015527/30.

tender response must be separated into its components as per the Price Schedule included with the tender documents. Local procurement content is total spending minus the imported component.

Tenderers are required to submit their proposals in the table below.

Local Procurement Content	Eskom target	Tenderer Proposal
	100%	

3. Procurement spends on entities with a minimum 51% black ownership.

Previous tenders proven that there are small and medium companies that are interested in this space; Therefore, successful supplier will be required to subcontract some of the scope of work to capable and competent EME/QSE with at least 51% BO. The main contractor will select from designated group that are not part of their subsidiaries or having shares in that company, preferable they should be selected from local to site.

Procurement from Designated Group	Eskom Target	Tenderer Proposal
Black Owned	25%	

NB: Tenderers are encouraged to make use of local to site suppliers from the Kriel /Matla Feeder areas for subcontracting opportunities

4. Jobs. Tenderers are required to submit proposals for the type and number of jobs that will be created and retained in South Africa as a direct result of being awarded a contract.

Type of Jobs to be created	Number of Jobs to be created

Type of Jobs to be retained	Number of Jobs to be retained

NB: Tenderers are encouraged to source candidates from the Kriel / Matla Feeder areas for job opportunities

5. Skills development

Tenderers are required to submit proposals in the table below for developing the skills of unemployed candidates in the country. Skills development is intended to address Eskom’s core, scarce and critical skills and scarce and critical skills. These skills are also included in a 2020 list of occupations in high demand as stipulated in the Government Gazette 43937. Candidates shall be from all provinces in

PUBLIC

When downloaded from the document management system, this document is uncontrolled and the responsibility rests with the user to ensure it is in line with the authorized version on the system. No part of this document may be reproduced without the expressed consent of the copyright holder, Eskom Holdings SOC Ltd, Reg. No 2002/015527/30.

the country, and their composition shall be representative of the population demographics of South Africa

Skill type / Occupation	Eskom target	Entry Level	Output	Tenderers Proposal
Civil Engineers	04	National Diploma or Equivalent	Work Integrated Learning	

NB: Tenderers are encouraged to source candidates from the Kriel / Matla Feeder areas for skills development opportunities.

The process of developing these skills shall involve the participation by tenderers directly and through their supply network. In certain cases, the SETA's accredited training providers can be approached to participate in developing critical and scarce skills.

Note: That these targets for skills development candidates categorically exclude Eskom employees and registered learners. The tenderers are required to take full responsibility for the total cost of developing the requisite skills, and Eskom shall not make any financial contribution towards the fulfilment of this obligation. Tenderers also are advised to approach their relevant SETAs to access grants, subsidies, and incentives as well as South African Revenue Services for tax rebates that are earmarked for skills development initiatives

Section 3: SDL&I Penalty and Performance Security

Eskom will apply a penalty of 2% of the Contract Value for failure to meet SDL&I obligations.

For the duration of the contract, Eskom will retain 2% of every invoice (excluding VAT) as security for the fulfilment of all SDL&I Obligations. The retained amounts shall only be released to the Contractor upon fulfilment of all SDL&I obligations by the contractor.

Section 4: Reporting and Monitoring

- The suppliers shall on a quarterly basis submit a report to Eskom in accordance with Data Collection Template on their compliance with the SDL&I obligations described above.
- Eskom shall review the SDL&I reports submitted by the suppliers within 30 (thirty) days of receipt of the reports and notify the suppliers in writing if their SDL&I obligations have not been met.
- Upon notification by Eskom that the suppliers have not met their SDL&I obligations, the suppliers shall be required to implement corrective measures to meet those SDL&I obligations before the commencement of the following report, failing which Retention clauses shall be invoked.
- Every contract shall be accompanied by the SDL&I Implementation Schedule, which must be completed by the suppliers and returned to SDL&I representative for acceptance 28 days after

PUBLIC

When downloaded from the document management system, this document is uncontrolled and the responsibility rests with the user to ensure it is in line with the authorized version on the system. No part of this document may be reproduced without the expressed consent of the copyright holder, Eskom Holdings SOC Ltd, Reg. No 2002/015527/30.

contract award. This will be used as a reference document for monitoring, measuring and reporting on the supplier's progress in delivering on their stated SDL&I commitments

Section 5: Market Research

The following information demonstrates market analysis and assists in arriving at the targets above.

Current Suppliers Providing the Services	Potential Suppliers:
<ul style="list-style-type: none"> None 	<ul style="list-style-type: none"> Open tender

Section 6: General Information on Validity of Sworn Affidavits

The following must be considered when it comes to validity of Affidavits;

Tenderers submitting B-BBEE Sworn Affidavits must ensure that the affidavits meet the following key pointers to ensure their validity:

- Name/s of deponent as they appear in the identity document and the identity number.
- Designation of the deponent as the **director, owner** or **member** must be indicated in order to know that person is duly authorised to depose of an affidavit. **(Mark the applicable option).**
- Name of enterprise as per enterprise registration documents issued by the CIPC, where applicable, and enterprise business address.
- Percentage of black ownership, black female ownership and designated group. In the case of specialised enterprises as per Statement 004, the percentage of black beneficiaries must be reflected. **(No blank spaces to be left).**
- Indicate total revenue for the year under review and whether it is based on **audited financial statements** or **management account.** **(Mark the applicable option).**
- Financial year end as per the **enterprise's registration documents**, which was used to determine the total revenue. **(Financial year end to be stipulated by day/month/year).**
- B-BBEE Status level. An enterprise can only have one status level. **(Tick applicable level)**
- Empowering supplier status must be indicated. For QSEs, the deponent must select the basis for the empowering supplier status.
- Date deponent signed and date of Commissioner of Oath must be the same. **(The sworn affidavit must be signed in the presence of the Commissioner of Oath. Furthermore the Commissioner must also sign and stamp)**
- Commissioner of Oath cannot be an employee or ex officio of the enterprise because, a person cannot by law, commission a sworn affidavit in which they have an interest.

Corporate Social Investment

Successful shall be expected to contribute 2% towards corporate social investment initiatives to benefit communities around Matla. This item shall be negotiated with the successful bidder.

Criteria	Expected CSI (%)	Target (%)	Proposal
CSI	2%	2%	

ANNEXURE A

AUTHORISATION FORM

Indicate the status of the *tenderer* by ticking the appropriate box below.

PUBLIC

When downloaded from the document management system, this document is uncontrolled and the responsibility rests with the user to ensure it is in line with the authorized version on the system. No part of this document may be reproduced without the expressed consent of the copyright holder, Eskom Holdings SOC Ltd, Reg. No 2002/015527/30.

A COMPANY	B CLOSE CORPORATION	C PARTNERSHIP	D JOINT VENTURE	E SOLE PROPRIETOR	F TRUST

The *tenderer* must complete the appropriate certificate set out below for its category of organisation. If the *tenderer* is a company, close corporation, joint venture, or trust the *tenderer* must attach a certified copy the document that is proof of the contents of the certificate (resolution of the board of directors of a company, members' resolution of a close corporation, power of attorney in the case of a joint venture, or resolution of the board of trustees of a trust).

Note further that, in addition to completing the relevant certificate for category of organisation, the authorised representative of the *tenderer* is also required to complete and sign the table at the end of this Authorisation Form.

A. Certificate for company

I, _____, in my capacity as _____ of the board of directors of _____, hereby confirm that by resolution of the board taken on _____ (date), Mr/Ms _____, acting in his/her capacity of _____, is authorised to submit this tender on behalf of the company, and to sign all documents in connection with this tender and any contract that may result from it on behalf of the company. A certified copy of the resolution of the board is annexed to this Form.

Signed:	Date:
Name:	Position:

B. Certificate for close corporation

I, _____, in my capacity as member of _____, hereby confirm that by majority vote of the members taken on _____ (date), Mr/Ms _____, acting in his/her capacity of _____, is authorised to submit this tender on behalf of the close corporation, and to sign all documents in connection with this tender and any contract that may result from it on behalf of the close corporation. A certified copy of the members' resolution is annexed to this Form.

PUBLIC

When downloaded from the document management system, this document is uncontrolled and the responsibility rests with the user to ensure it is in line with the authorized version on the system. No part of this document may be reproduced without the expressed consent of the copyright holder, Eskom Holdings SOC Ltd, Reg. No 2002/015527/30.

Signed:	Date:
Name:	Position:

C. Certificate for partnership

We, the undersigned, being the **key partners** in the business trading as _____
 _____ hereby authorise Mr/Ms _____, acting in his/her
 capacity of _____, to submit this tender on behalf of the partnership,
 and to sign all documents in connection with the tender and any contract that may result from it on
 behalf of the partnership.

Name	Address	Signature	Date

NOTE: This certificate is required to be completed and signed by the full number of Partners necessary to commit the Partnership. Attach additional pages if more space is required.

D. Certificate for Joint Venture

We, the undersigned, are submitting this tender offer in Joint Venture and hereby authorise Mr/Ms _____
 _____, an authorised signatory of _____
 _____, being the lead member in the Joint Venture, to sign all documents in connection
 with the tender and any contract that may result from it on behalf of all the members in the Joint
 Venture.

This authorisation is evidenced by the attached power of attorney signed by the legally authorised
 signatories of all the members in the Joint Venture.

We attach to this Form a certified copy of the Joint Venture Agreement which incorporates a statement
 that all members in the Joint Venture are liable jointly and severally for the execution of the contract,
 a term that indicates which member will be the lead member, and terms that indicate the ratios
 according to which work and payment will be divided amongst the members.

PUBLIC

When downloaded from the document management system, this document is uncontrolled and the
 responsibility rests with the user to ensure it is in line with the authorized version on the system. No part of
 this document may be reproduced without the expressed consent of the copyright holder, Eskom Holdings
 SOC Ltd, Reg. No 2002/015527/30.

Name of JV member	Address	Authorised signature, name, and capacity
Lead member		
Member		
Member		
Member		

NOTE: This certificate is required to be completed and signed by all members of the joint venture. Attach additional pages if more space is required.

E. Certificate for sole proprietor

I, _____, hereby confirm that I am the sole proprietor of the business trading as _____

Signed:	Date:
Name:	Position:(Sole Proprietor)

F. Certificate for trust

I, _____, in my capacity as _____ of the board of trustees of _____, hereby confirm that by resolution of the board of trustees taken on _____ (date), Mr/Ms _____, acting in his/her capacity of _____, is authorised to submit this tender on behalf of the trust and to sign all documents in connection with this tender and any contract that may result from it on behalf of the trust. A certified copy of the resolution of the board of trustees is annexed to this Form.

Signed:	Date:
Name:	Position:

NOTE: The table below must also be fully completed by all tenderers in addition to the certificate that was selected and completed above.

PUBLIC

When downloaded from the document management system, this document is uncontrolled and the responsibility rests with the user to ensure it is in line with the authorized version on the system. No part of this document may be reproduced without the expressed consent of the copyright holder, Eskom Holdings SOC Ltd, Reg. No 2002/015527/30.

Name of tenderer:	
Full names of authorised signatory:	
Designation and capacity:	
Signature of authorised signatory	
Date of signature:	

ANNEXURE B

ACKNOWLEDGEMENT FORM

We are in receipt of the Invitation to Tender/Proposal from Eskom Holdings SOC Ltd and the following addenda issued by Eskom:

We confirm that the documentation received by us is: ***(Indicate by ticking the box)***

Correct as stated in the Invitation to Tender / RFP Content List, and that each document is complete.

Or: Incorrect or incomplete for the following reasons:

Cataloguing Acknowledgement:

Please select the relevant statement by ticking the appropriate box below:

1. We agree to provide the cataloguing information as described in the Invitation to Tender
2. We have already supplied Eskom with the cataloguing information pertaining to this Invitation to Tender in a previous contract/order [***insert previous contract/order number***] _____
3. We do not intend to provide the required cataloguing information for the reasons stated hereunder:

PUBLIC

When downloaded from the document management system, this document is uncontrolled and the responsibility rests with the user to ensure it is in line with the authorized version on the system. No part of this document may be reproduced without the expressed consent of the copyright holder, Eskom Holdings SOC Ltd, Reg. No 2002/015527/30.

4. We are a Distributor/Importer/Agent and our Principal, being the Original Equipment Manufacturer (OEM), is or is not [***delete whichever is not applicable***] in the position to supply cataloguing information for items. We attach the letter from the OEM confirming its position.

Invitation to Tender/Request for Proposal No: _____

Name of Tenderer: _____

Country of registration: _____

Full names of contact person: _____

Contact details:

Tel (landline):
Cell phone:
e-mail address:

Name of tenderer:	
Full names of authorised signatory:	
Signature:	
Designation and capacity:	
Date:	

ANNEXURE C

TENDERER'S PARTICULARS

The tenderer must furnish the following particulars where applicable:

Indicate the type of tendering structure by marking with an 'X' (where applicable provide registration number):	
Individual tenderer	
Unincorporated Joint venture (registration number for each member of the JV)	
Incorporated JV	
Other	

PUBLIC

When downloaded from the document management system, this document is uncontrolled and the responsibility rests with the user to ensure it is in line with the authorized version on the system. No part of this document may be reproduced without the expressed consent of the copyright holder, Eskom Holdings SOC Ltd, Reg. No 2002/015527/30.

Please complete the following:

Name of lead partner/member in case of JV	
CIPC Registration Number or CIPC disclosure certificate (for individual companies and each JV member) or trust number.	
VAT registration number (for individual companies and each JV member)	
CIDB registration number (for individual companies and each JV member), contractor grading designation (for individual companies and each JV member) and combined cidb contractor grading designation (for JVs)	
Contact person	
Telephone number	
E-mail address	
Postal address (also of each member in the case of a JV)	
Physical address (also of each member in the case of a JV)	

If subcontractors are to be used, indicate the following for the main sub-contractor(s). Add to the list of applicable.

Name of contractor	
CIPC Registration number or CIPC disclosure certificate	
VAT registration number	
CIDB Registration number (if applicable) and CIDB grade specified for the sub-contractor as may be stipulated in the Tender Data	
Proposed Scope of work to be done by sub-contractor	
Contact person	
Telephone number	
Fax number	
E-mail address	
Postal address	
Physical address	

1. If you are currently registered as a vendor with Eskom, please provide your vendor registration number with Eskom. _____

PUBLIC

When downloaded from the document management system, this document is uncontrolled and the responsibility rests with the user to ensure it is in line with the authorized version on the system. No part of this document may be reproduced without the expressed consent of the copyright holder, Eskom Holdings SOC Ltd, Reg. No 2002/015527/30.

2. If you are currently registered as a vendor on the National Treasury's Central Supplier Database (CSD), please provide your supplier registration number with Treasury_____
3. Please note that it is not mandatory for you to be registered on National Treasury's CSD at the time of responding to this tender. It is, however, a mandatory requirement that you be registered on CSD prior to award.
4. You may register online at National Treasury website on www.treasury.gov.za
5. If you are registered on SARS E-filing system, please provide your PIN number in order to verify your tax compliance status _____
6. If you are required to be tax compliant as per SBD 1 but are not registered on CSD (foreign suppliers) or have not provided your SARS E-filing PIN, please confirm that you have attached or will furnish a copy of a current valid tax compliance certificate as a tender returnable by contract award stage.

YES		NO	

7. If sub-contracting is prescribed in the Invitation to Tender, tenderers must complete 7.1 to 7.9.

7.1 Confirm if you intend sub-contracting

YES		NO	
-----	--	----	--

7.2 What percentage will you be sub-contracting? _____%

7.3 To whom do you intend sub-contracting? _____

7.4 Is the said sub-contractor registered on CSD?

YES		NO	
-----	--	----	--

7.5 If yes to 8.4, please provide CSD number. _____

7.6 Please confirm B-BBEE level of said sub-contractor _____

7.7 Which designated group does the sub-contractor belong to: -

- a) An EME or QSE.
- b) An EME or QSE which is at least 51% owned by black people;
- c) An EME or QSE which is at least 51% owned by black people who are youth;
- d) An EME or QSE which is at least 51% owned by black people who are women;
- e) An EME or QSE which is at least 51% owned by black people with disabilities;
- f) An EME or QSE which is 51% owned by black people living in rural or underdeveloped areas or townships;
- g) A cooperative which is at least 51% owned by black people;

PUBLIC

When downloaded from the document management system, this document is uncontrolled and the responsibility rests with the user to ensure it is in line with the authorized version on the system. No part of this document may be reproduced without the expressed consent of the copyright holder, Eskom Holdings SOC Ltd, Reg. No 2002/015527/30.

- h) An EME or QSE which is at least 51% owned by black people who are military veterans; or
- i) More than one of the categories referred to in paragraphs (a) to (h).

7.8 Please confirm that you have attached your signed intention to sub-contract document.

YES	<input type="checkbox"/>	NO	<input type="checkbox"/>
-----	--------------------------	----	--------------------------

7.9 Have you attached proof of sub-contractor's belonging to designated group?

YES	<input type="checkbox"/>	NO	<input type="checkbox"/>
-----	--------------------------	----	--------------------------

Name of tenderer:	
Full names of authorised signatory:	
Signature:	
Designation and capacity:	
Date:	

ANNEXURE D

INTEGRITY DECLARATION FORM

Note: This returnable is required to be fully completed, signed and submitted by tenderers at the stipulated deadlines.

1 DECLARATION OF INTEREST

I/We understand that an employee of the State as defined in the Public Service Act of 1994 is prohibited from conducting business with any organ of state and from being a director of a public or private company that conducts business with an organ of state.

I/We understand that any natural/legal person, including any natural legal person related to an Eskom employee/director as per the definition of "related" set out hereunder, may submit a tender to Eskom. However, in order to establish whether a conflict of interest exists tenderers are required to declare such interest/relationships where: -

1. the *tenderer/s* employees/directors are also employees/contractors/consultants/directors of Eskom.
2. the *tenderer/s* employees/directors are also employees/contractors/consultants or directors in another entity together with Eskom employees/consultants/contractors'/ directors.
3. the *legal entity including its employees/contractors/ directors / shareholders /members /partners / owners* on whose behalf the tender documents are signed, is/are in some other way related to an Eskom employee/contractor/consultant/director involved in the tender specification/ tender evaluation/tender adjudication/negotiation.
4. the tenderer/s and one or more other tenderers in this tendering/RFP process have a controlling partner in common, or have a relationship with each other, directly or through common third parties, that puts them in a position to have access to information about or influence over the

PUBLIC

When downloaded from the document management system, this document is uncontrolled and the responsibility rests with the user to ensure it is in line with the authorized version on the system. No part of this document may be reproduced without the expressed consent of the copyright holder, Eskom Holdings SOC Ltd, Reg. No 2002/015527/30.

tender/proposal of another tenderer, or influence over the decisions of Eskom regarding the bidding process;

Related:

- (1) When used in respect of two persons, means persons who are connected to one another in any manner contemplated below:
- (a) an individual is related to another individual if they-
 - (i) are married, or live together in a relationship similar to a marriage; or
 - (ii) are separated by no more than two degrees of natural or adopted consanguinity or affinity;
 - (b) an individual is related to a juristic person if the individual directly or indirectly controls the juristic person, as determined in accordance with the definition of control as set out in subsection (2) below; and
 - (c) a juristic person is related to another juristic person if-
 - (i) either of them directly or indirectly controls the other, or the business of the other, as determined in accordance with subsection (2) below;
 - (ii) either is a subsidiary of the other; or
 - (iii) a person directly or indirectly controls each of them, or the business of each of them, as determined in accordance with subsection (2) below.

“related person”, when used in reference to a directors/shareholders/members/partners/owners, has the meaning set out in 3.3.16, but also includes a second company of which the directors/shareholders/members/partners/owners or a related person is also a director directors/shareholders/members/partners/owners, or a close corporation of which the director or a related person is a member.

Control:

- (2) For the purpose of subsection (1) above, a person controls a juristic person, or its business, if-
- (a) in the case of a juristic person that is a company-
 - (i) that juristic person is a subsidiary of that first person, as determined in accordance with the Companies Act¹; or
 - (ii) that first person together with any related or inter-related person, is-

PUBLIC

When downloaded from the document management system, this document is uncontrolled and the responsibility rests with the user to ensure it is in line with the authorized version on the system. No part of this document may be reproduced without the expressed consent of the copyright holder, Eskom Holdings SOC Ltd, Reg. No 2002/015527/30.

(aa) directly or indirectly able to exercise or control the exercise of a majority of the voting rights associated with securities of that company, whether pursuant to a shareholder agreement or otherwise; or

(bb) has the right to appoint or elect, or control the appointment or election of, directors of that company who control a majority of the votes at a meeting of the board;

- (b) in the case of a juristic person that is a close corporation, that first person owns the majority of the members' interest, or controls directly, or has the right to control, the majority of members' votes in the close corporation;
- (c) in the case of a juristic person that is a trust, that first person has the ability to control the majority of the votes of the trustees or to appoint the majority of the trustees, or to appoint or change the majority of the beneficiaries of the trust; or
- (d) that first person has the ability to materially influence the policy of the juristic person in a manner comparable to a person who, in ordinary commercial practice, would be able to exercise an element of control referred to in paragraph (a), (b) or (c) of subsection (2).

"To give effect to the provisions above, please complete the table hereunder with all required information.

Full Name & Capacity/ Position within tenderer (e.g. employee/Director/member/ owner/shareholder)	Identity Number	Confirm and provide details (including employee number) if you are an employee/consultant/ contractor and/or director of a State/State owned entity.	Full Names & Capacity/Position of Eskom employee/ consultant/contractor and/or director details of the relationship or interest (marital/ familial/personal/ financial etc.)	To your knowledge is this person involved in the specification/ evaluation/ adjudication/ negotiation of tenders?

If any employee/director/member/shareholder/owner of the tenderer/s is also currently employed by Eskom, state whether this has been declared and whether there is authorisation to undertake remunerative work outside public sector employment and attach proof to this declaration. _____[Yes/No]

Do the tenderer/s and any other tenderer/s in this tendering/RFP process share a controlling partner or have any relationship with each other, directly or through common third parties? _____[Yes/No]

If yes, attach proof. to this declaration

2 DECLARATION OF FAIR TENDERING PRACTICES

The tenderer declares that it has taken all reasonable steps to address and prevent the exploitation of the procurement process and the use of any unfair tendering practices.

PUBLIC

When downloaded from the document management system, this document is uncontrolled and the responsibility rests with the user to ensure it is in line with the authorized version on the system. No part of this document may be reproduced without the expressed consent of the copyright holder, Eskom Holdings SOC Ltd, Reg. No 2002/015527/30.

A [tender/proposal] will be disqualified if the tenderer/s, or any of its directors have:

1. abused Eskom's procurement process (e.g. bid rigging/collusion); or
2. committed fraud or any other improper conduct in relation to such procurement process.

Please complete the declaration with an 'X' under YES or NO

Item	Question	Yes	No
1.1	Is the tenderer/s or any of its shareholders/ directors/ members/ partners/ owners/ trustees/ beneficiaries listed on National Treasury's Database of Restricted Suppliers as companies/persons prohibited from doing business with the public sector. The Database of Restricted Suppliers can be accessed on the National Treasury's website (www.treasury.gov.za).		
1.2	Is the tenderer/s or any of its shareholders/directors/members/partners/owners/trustees/beneficiaries listed on the Register for Tender Defaulters in terms of section 29 of the Prevention and Combatting of Corrupt Activities Act (No 12 of 2004) The Register for Tender Defaulters can be accessed on the National Treasury's website (www.treasury.gov.za).		
1.3	Was the tenderer/s or any of its shareholders/directors/members/partners/owners/trustees/beneficiaries convicted by a court of law (including a court outside South Africa) of fraud and/or corruption in respect of any procurement/tendering processes/procedures during the past five years?		
1.3.1	If "Yes", provide details including a case number and a copy of the judgement.		
1.4	Was the tenderer/s or any of its shareholders/ directors/ members/ partners/ owners/ trustees/ beneficiaries prohibited from doing business with any International Financial/Lending Institution or Development/ Funding Agency?		
1.5	Is there any history/record of the tenderer/s or any of its shareholders/directors/members/partners/owners/turstees/beneficiaries failing to meet their contractual obligation with the State or any State-Owned Entity (SOC)?		
1.5.1	If "Yes", provide details		
1.6	Is the tenderer/s or any of its directors restricted by Eskom?		

3. DECLARATION OF SHAREHOLDING / BENEFICIARY INFORMATION

I, the undersigned _____ [Full names and Position] _____
 hereby declare that I am the duly authorised representative of _____ [Name of Tenderer].

I further declare that the following individuals and/or entities listed hereunder are Shareholders / Beneficiaries
 in _____ [Name of Tenderer]:

PUBLIC

When downloaded from the document management system, this document is uncontrolled and the responsibility rests with the user to ensure it is in line with the authorized version on the system. No part of this document may be reproduced without the expressed consent of the copyright holder, Eskom Holdings SOC Ltd, Reg. No 2002/015527/30.

Note that the information in the tables hereunder must be completed for each tenderer (including incorporated JVs). If the tenderer is an unincorporated JV, the tables must be completed for each JV member. Please add additional rows if required.

Individuals:

Full Name	Identity Number	Shareholding Percentage / Beneficiary Share

Other Entities*:

Full Legal / Trading Name	Entity Registration Number/Trust Number	Shareholding Percentage / Beneficiary Share	Full name and surname of the /shareholders/ directors/ trustees/ beneficiaries of the shareholding entity	Identification Numbers of the shareholders/directors/ trustees/beneficiaries of the shareholding entity

I declare that I have read and understood the provisions of the Supplier Integrity Pact, that all information furnished herein is true and correct, that it is understood that the tenderer's tender/proposal may be rejected, and that Eskom will act against the tenderer should any aspect of this declaration prove to be false, and

I give my consent for this information to be used for the purpose as described in this Integrity Declaration Form and/or in relation to the Supplier Integrity Pact, and

I further consent that information provided in terms of this Integrity Declaration Form may be processed for verification of conflicts of interest and other ancillary purposes by Eskom. Such processing may include the sharing of the information with third parties.

Name of Tenderer:	
Full names of authorised signatory:	

PUBLIC

When downloaded from the document management system, this document is uncontrolled and the responsibility rests with the user to ensure it is in line with the authorized version on the system. No part of this document may be reproduced without the expressed consent of the copyright holder, Eskom Holdings SOC Ltd, Reg. No 2002/015527/30.

Signature:	
Designation and capacity:	
Date:	

Joint Ventures

I declare that I have read and understood the provisions of the Supplier Integrity Pact, that all information furnished herein is true and correct that it is understood that the JV's tender/proposal may be rejected, and that Eskom will act against the JV should any aspect of this declaration prove to be false; and

I give my consent for this information to be used for the purposes described in this Integrity Declaration Form and/or in relation to the Supplier Integrity Pact, and

I further consent that information provided in terms of this Integrity Declaration Form may be processed for verification of conflicts of interest and other ancillary purposes by Eskom. Such processing may include the sharing of the information with third parties.

Name of Tenderer:	
Full names of authorised signatory:	
Signature:	
Designation and capacity:	
Date:	

PUBLIC

When downloaded from the document management system, this document is uncontrolled and the responsibility rests with the user to ensure it is in line with the authorized version on the system. No part of this document may be reproduced without the expressed consent of the copyright holder, Eskom Holdings SOC Ltd, Reg. No 2002/015527/30.

ANNEXURE E

CONTRACT PRICE ADJUSTMENT (CPA) REQUIREMENTS FOR LOCAL GOODS AND SERVICES.

The application of contract price adjustment (CPA) to tender submissions

Note: This Section will not be applicable to Professional services contracts (See relevant section hereunder for guidelines on this).

1. Application of CPA

- CPA conditions may apply if the contractual duration is to be longer than 12 months.
- If the contractual duration will be less than or equal to 12 months, a fixed priced offer must be submitted.
- For contracts with a duration more than twelve (12) months, CPA will not be applicable for the first year. CPA will then only be applied from year two (2) onwards.
- Failure to propose contract price adjustment, or submit a CPA formula with the tender submission, will result in the pricing being considered fixed.
- Eskom will not accept Rate of Exchange adjustment to be included in any CPA formula.
- Local indices may not be used for CPA purposes for any imported component.
- There must be separate CPA formulae for local and foreign CPA. Local and foreign escalation may not be combined into one formula.

2. Tender Submissions

[Procurement Practitioner/QS to populate table hereunder as per scope of work for relevant Tender]

Eskom Proposed CPA breakdown for Local Goods and Service

Formula A						
Index Reference	Proposed portions/Weightings of each index	Description of Index	Full Title of Index published	Source Publisher of Index	Base Month	Base Price/Base Index Figure
A1						
A2						
A3						
	15%	<i>Fixed portion not subject to CPA</i>				
Total	100%					

Note: Tenderers to take note that, if the Eskom proposed CPA breakdown is not populated, they are required to refer to the Pricing Schedule in the NEC or other Contract or standalone Pricing Schedule for Eskom’s proposed CPA breakdown.

Eskom CPA Conditions/Requirements

- Tenderers are required to submit CPA that is aligned to Eskom’s proposed CPA breakdown in this Tender; or Tenderers may submit an alternative CPA proposal from Eskom’s CPA proposal, and this will be considered if deemed acceptable to Eskom;

PUBLIC

When downloaded from the document management system, this document is uncontrolled and the responsibility rests with the user to ensure it is in line with the authorized version on the system. No part of this document may be reproduced without the expressed consent of the copyright holder, Eskom Holdings SOC Ltd, Reg. No 2002/015527/30.

- Note that for contracts exceeding a duration of 12 months if there is no CPA catered for by the tenderer; then prices will be deemed to be fixed and firm.
- A minimum of 15% of the total agreement value is to be fixed when a CPA formula is applied,
- Each CPA formula must add up to a final total of 100.
- Only official published CPA indices that are in the public domain must be used.
- No in-house indices may be used for CPA.
- There may be more than 1 CPA formula (Formula A, B, C etc.) or a combination of all the cost components into 1 Formula (depending on how the pricing is to be submitted).
- If there are specific line items for Labour and Transport, individual Formulae might be used.

Note: Eskom reserves the right to negotiate CPA terms and conditions during negotiations held with tenderers.

3. BASE DATE AND BASE PRICE

- In instances of indices or other references published monthly, the Base Date is to be the month before the month in which the tender closes.
- In instances where the reference figures, e.g. market prices, are published daily or at intervals more than once a month; then the average for the month before the month in which the tender closes should be used as the Base Price.

4. CPA FOR PROFESSIONAL SERVICES

- The preferred index to be used for adjusting these agreements is the country specific CPI Headline index.
- The price adjustment factor will be effective from each contractual anniversary of the contract date. This must be the average of the country specific CPI Headline index figures published for the last twelve-month period (cycle) ending before the contract anniversary date.

OR

Closing date of tender:	
Name of tenderer:	
Full names of authorised signatory:	
Signature:	
Date of signature:	

ANNEXURE F

CPA (IG) REQUIREMENTS FOR FOREIGN GOODS AND SERVICES

The application of contract price adjustment (CPA) to tender submissions

Note: This Section will not be applicable to Professional services contracts (See relevant section hereunder for guidelines on this).

PUBLIC

When downloaded from the document management system, this document is uncontrolled and the responsibility rests with the user to ensure it is in line with the authorized version on the system. No part of this document may be reproduced without the expressed consent of the copyright holder, Eskom Holdings SOC Ltd, Reg. No 2002/015527/30.

1. Application of CPA

- CPA conditions may apply if the contractual duration is to be longer than 12 months.
- If the contractual duration will be less than or equal to 12 months, a fixed priced offer must be submitted.
- For contracts with a duration more than twelve (12) months, CPA will not be applicable for the first year. CPA will then only be applied from year two (2) onwards.
- Failure to propose contract price adjustment, or submit a CPA formula with the tender submission, will result in the pricing being considered fixed.
- Eskom will not accept Rate of Exchange adjustment to be included in any CPA formula.
- Local indices may not be used for CPA purposes for any imported component.
- There must be separate CPA formulae for local and foreign CPA. Local and foreign escalation may not be combined into one formula.

2. Tender Submissions

[Procurement Practitioner/QS to populate table hereunder as per scope of work for relevant Tender]

Eskom Proposed CPA breakdown for Foreign Goods and Service

Formula A						
Index Reference	Proposed portions/Weightings of each index	Description of Index	Full Title of Index as published	Source Publisher of Index	Base Month	Base Price/Base Index Figure
A1						
A2						
A3						
	15%	Fixed portion not subject to CPA				
Total	100%					

Note: Tenderers to take note that, if the Eskom proposed CPA breakdown is not populated, they are required to refer to the Pricing Schedule in the NEC or other Contract or standalone Pricing Schedule for Eskom’s proposed CPA breakdown.

Eskom CPA Conditions/Requirements

- Tenderers are required to submit CPA that is aligned to Eskom’s proposed CPA breakdown in this Tender; or Tenderers may submit an alternative CPA proposal from Eskom’s CPA proposal and this will be considered if deemed acceptable to Eskom;
- Note that for contracts exceeding a duration of 12 months if there is no CPA catered for by the tenderer; then prices will be deemed to be fixed and firm.
- A minimum of 15% of the total agreement value is to be fixed when a CPA formula is applied,
- Each CPA formula must add up to a final total of 100.
- Only official published CPA indices that are in the public domain must be used.
- No in-house indices may be used for CPA.
- There may be more than 1 CPA formula (Formula A, B, C etc) or a combination of all the cost components into 1 Formula (depending on how the pricing is to be submitted).
- If there are specific line items for Labour and Transport, individual Formulae might be used.

PUBLIC

When downloaded from the document management system, this document is uncontrolled and the responsibility rests with the user to ensure it is in line with the authorized version on the system. No part of this document may be reproduced without the expressed consent of the copyright holder, Eskom Holdings SOC Ltd, Reg. No 2002/015527/30.

Note: Eskom reserves the right to negotiate CPA terms and conditions during negotiations held with tenderers.

3. BASE DATE AND BASE PRICE

- In instances of indices or other references published monthly, the Base Date is to be the month before the month in which the tender closes
- In instances where the reference figures, e.g. market prices, are published daily or at intervals more than once a month; then the average for the month before the month in which the tender closes should be used as the Base Price.

4. CPA FOR PROFESSIONAL SERVICES

- The preferred index to be used for adjusting these agreements is the country specific CPI Headline index.
- The price adjustment factor will be effective from each contractual anniversary of the contract date. This must be the average of the country specific CPI Headline index figures published for the last twelve-month period (cycle) ending before the contract anniversary date.

PAYMENT OF FOREIGN COMMITMENTS

PART 1: The application of importation payment requirements to tender submissions.

Where foreign exchange is involved, Eskom will take measures to mitigate any exposure to foreign currency exposure or exchange rate risk.

Tenderers: -

- Who wish to submit tenders with pricing in foreign currency for imported goods/services must establish **prior** to tender close (via the Procurement Practitioner), that the foreign currency that is being priced in the submission, is an acceptable foreign currency to Eskom.
- Who are pricing for imported goods/services in a foreign currency or linking their pricing of goods to a foreign currency exchange rate, **must be the direct importers** of the goods/services. For payment purposes, Eskom will require proof of importation.
- Who import goods into stock, for delivery to various customers, including Eskom, the price quoted must be in South African Rand. In such cases, Eskom will not undertake any foreign exchange commitment or arrange forward cover.
- Who have submissions where pricing for imported goods/services in a foreign currency or linked to a foreign currency exchange rate, must ensure that their pricing indicates the foreign currency and the foreign currency values.

Tenderers should note that all domestic value-added process, i.e., costs incurred in the Republic of South Africa, for example, transport costs will only be paid in Rands.

Tenderers who have submitted tenders, which have goods/services priced, are linked to a foreign currency or exchange rate, are required to select one of the payment methods indicated below for the payment relating to those imported goods/services:

Payment of Eskom's foreign commitment in foreign currency will be made either:

Payment Method 1A:

PUBLIC

When downloaded from the document management system, this document is uncontrolled and the responsibility rests with the user to ensure it is in line with the authorized version on the system. No part of this document may be reproduced without the expressed consent of the copyright holder, Eskom Holdings SOC Ltd, Reg. No 2002/015527/30.

To a nominated bank account in a foreign country in a foreign currency
(Payment will be made to the party and account nominated by the supplier
In the contract, and not to any other party).

Please note that the contracting party OR Eskom SOC Limited must be the direct importer of the goods

Documentation to be submitted with payment:

- Commercial invoice (from the foreign supplier)

Import payments

- SAD 500
- Bill of Entry as evidence that goods have been cleared by the Department of Customs and Excise
- Customs release notification
- Transport documents from the freight company
- Marine/ ocean bill of lading

Any one of the following documents as per the mode of transportation: -

- Airway bill / air transport document
- Road or rail consignment note.
- Postal receipt "goods despatched".
- Certificate of posting
- Courier dispatch note or air waybill.

NB: Evidencing transport of the relative goods to the Republic of South Africa

Service- related payments

Documents to submit with payment:

- Commercial invoice (invoice from the overseas supplier)

Delete which is not applicable (Yes/No)]

OR

Payment Method 1B.

To a valid SARB approved CFC account in South Africa, in a foreign currency (payment will be made to the contracting party)

Please note:

- The contracting party must be the direct importer.
- For payment purposes, Eskom will require both the foreign (commercial) invoice and the local tax invoice.
- The foreign currency values on both the commercial and local invoice must match. Eskom will not pay any profit in foreign currency. (Please note that the commercial invoice used in the clearance of the imported goods must be from the country of origin)

PUBLIC

When downloaded from the document management system, this document is uncontrolled and the responsibility rests with the user to ensure it is in line with the authorized version on the system. No part of this document may be reproduced without the expressed consent of the copyright holder, Eskom Holdings SOC Ltd, Reg. No 2002/015527/30.

- If Payment Method 1B is the option selected for the payment for any imported goods/services, then the following documentation is to be submitted with your submission:
 - Copy of tenderers bankers' initial application to the Reserve Bank requesting approval to invoice a local entity or Eskom, and for Eskom to pay the invoiced currency into the contracting party's CFC account.
 - Copy of the response from the Reserve Bank regarding the initial application, on the Reserve Bank's letterhead
 - Copy of the latest application to the Reserve Bank to renew the approval.
 - Copy of the response from the Reserve Bank to the application to renew the approval to invoice Eskom in foreign currency.

Documents to submit with payment:

- Commercial invoice (from the foreign supplier, country of origin and used to clear the goods)
- Local invoice or Tax invoice
- Both the commercial invoice and local invoices must match

Import payments

- SAD 500
- Bill of Entry as evidence that goods have been cleared by the Department of Customs and Excise
- Customs release notification
- Transport documents from the freight company

Any of the following documents as per the mode of transportation: -

- Marine/ ocean bill of lading
- Airway bill / air transport document
- Road or rail consignment note.
- Postal receipt
- Certificate of posting
- Courier dispatch note or air waybill.

NB: Evidencing transport of the relative goods to the Republic of South Africa

All documents submitted to Eskom should not have any alterations.

The information on the documents should be as originally issued from the authorities, freight companies and overseas suppliers.

Service-related payments

- Should a supplier select this option, they are required to provide proof that the South African Reserve Bank has given them approval to invoice Eskom in foreign currency for services related payments and to receive foreign currency proceeds into that CFC account. The proof would consist of: -
 - A copy of a letter from the supplier's bankers to the Reserve Bank requesting authority to receive services related payments to be made into a CFC account.
 - A copy of the official response from the Reserve Bank authorising payments to be made into the supplier's CFC account. The supplier's documents to the Reserve Bank must make specific reference to Eskom.
- This approval is only valid for a period of 1 year or as per SARB approval period.

Documents to submit with payment:

PUBLIC

When downloaded from the document management system, this document is uncontrolled and the responsibility rests with the user to ensure it is in line with the authorized version on the system. No part of this document may be reproduced without the expressed consent of the copyright holder, Eskom Holdings SOC Ltd, Reg. No 2002/015527/30.

- Commercial invoice (invoice from the overseas supplier to proof that we have foreign currency exposure)
- Local Tax invoice (from the local supplier)
- Both the commercial invoice and local invoices must match

NB: If a supplier is unable to produce or provide Eskom with a commercial invoice, the contract will be concluded in rands. The contract cannot be linked to any Exchange Rate.

[Delete which is not applicable (Yes/No)]

OR

Payment Method 2:

In South African Rand at the selling spot rate of exchange obtained by Eskom's Treasury on the date that the forward cover is cancelled. Eskom will notify the supplier of the date that the forward cover is cancelled as well
As the intended payment date, which will be as per the agreed payment terms.
Any exchange rate adjustment after Eskom has notified the supplier of the date and the rate which the forward cover is cancelled, will be for the account of the supplier.

Please note:

- The contracting party must be the direct importer of the goods.
- This payment option is not applicable for the payment of services
- Tenderers are required to indicate and request approval from Eskom to use Payment Method 2 **prior to tender close**. Where a tenderer has failed to obtain the required approval prior to tender close, the tenderer will have to select one of the other Payment Methods indicated in this document.
- Together with their submission, Tenderers will be required to provide Eskom with a written indemnity confirming that they will not buy and forward cover.,

Documents to submit with payment:

- Commercial invoice (from the foreign supplier)
- SAD 500
- Bill of Entry as evidence that goods have been cleared by the Department of Customs and Excise
- Customs release notification
- Transport documents from the freight company

Any of the following documents as per the mode of transportation: -

- Marine/ ocean bill of lading
- Airway bill / air transport document
- Road or rail consignment note
- Postal receipt
- Certificate of posting
- Courier dispatch note or air waybill

NB: Evidencing transport of the relative goods to the Republic

PUBLIC

When downloaded from the document management system, this document is uncontrolled and the responsibility rests with the user to ensure it is in line with the authorized version on the system. No part of this document may be reproduced without the expressed consent of the copyright holder, Eskom Holdings SOC Ltd, Reg. No 2002/015527/30.

- Local invoice or Tax invoice

NB: If a supplier is unable to produce or provide Eskom with a commercial invoice, the contract will be concluded in rands. The contract cannot be linked to any Exchange Rate.

[Delete which is not applicable (Yes/No)]

OR

Fixed ZAR Option (Payment Method 3)

This option is available to those tenderers who are the direct importers of the goods/services for which they have tendered, but do not find Payment Methods 1A, 1B or 2 and allows tenderers to be responsible for the foreign currency and exchange rate risk. If a tenderer selects this payment method, the process is as follows:

- Eskom and the successful tender will engage, on a simultaneous basis, with their respective bankers and compare the exchange rate/s obtained. This is done to ensure that any exchange rate/s used is/are market related.
- Tenderers will be required to match or better the exchange rate/s obtained by Eskom. If the tenderer's exchange rate/s is/are more expensive than the exchange rate/s indicated by Eskom, the exchange rate/s to convert the foreign values into ZAR will be the Eskom exchange rate/s.
- Once the exchange rate/s has/have been agreed by both parties, Eskom will not be liable for any further exchange rate adjustments.

From a Commercial perspective, please take note of the following:

- The foreign currency and foreign currency amount/s that Eskom is/are at risk to, need/s to be indicated in the pricing schedule submitted as part of the tender. If the pricing schedule does not allow for it, the foreign currency and foreign currency amount/s must be indicated in a covering letter.
- The exchange rate to be used in the tender submission is the exchange rate sourced from the South African Reserve Bank on the date the tender is advertised/published.
- Due to the payments being made in ZAR, but based on an agreed exchange rate, the tenderer will be required to submit proof of importation at time of payment.

Delete which is not applicable (Yes/No)]

Documents to submit with payment:

- Commercial invoice (from the foreign supplier)
- Local invoice or Tax invoice

Import payments

- SAD 500
- Bill of Entry as evidence that goods have been cleared by the Department of Customs and Excise
- Customs release notification
- Transport documents from the freight company

PUBLIC

When downloaded from the document management system, this document is uncontrolled and the responsibility rests with the user to ensure it is in line with the authorized version on the system. No part of this document may be reproduced without the expressed consent of the copyright holder, Eskom Holdings SOC Ltd, Reg. No 2002/015527/30.

Any of the following documents as per the mode of transportation: -

- Marine/ ocean bill of lading
- Airway bill / air transport document
- Road or rail consignment note.
- Postal receipt
- Certificate of posting
- Courier dispatch note or air waybill.

NB: Evidencing transport of the goods to the Republic of South Africa

Documents to submit with payment:

- Commercial invoice (invoice from the overseas supplier to proof that we have foreign currency exposure)
- Local Tax invoice (from the local supplier)

NB: If a supplier is unable to produce or provide Eskom with a commercial invoice, the contract will be concluded in RAND's Not in Currency

[Delete which is not applicable (Yes/No)]

Please note: Eskom will require substantiating proof of importation at the time of invoicing.

Where the supplier, previously imported goods into stock for delivery to various customers, including Eskom, the price quoted must be in South African Rand. In such cases, Eskom will not undertake any foreign exchange commitment or arrange forward cover.

Take note of the following:

Service-related payment:

When specialist skills are required in South Africa, the local supplier will source the appropriate talent from their network of specialist companies overseas. The specialist is then brought into the country (South Africa) on one of two possible methodologies.

1) **Secondment**

In this approach, the foreign specialist retains their employment contract with their home unit (Employer overseas) but are seconded to the local company that has a contract with Eskom to work under the direction and control of the local management. Their salaries are paid to the foreign specialist by their home country and that foreign entity then invoices the local supplier (South Africa) in foreign currency for the cost relating to such employees. The invoices would typically be in Euro or GBP, this methodology is usually for short to medium term engagements.

Documents to be attached for payment:

- Commercial invoice from the specialist company
- Local invoice (South African company making use of the specialist services)
- Passport of the specialist and valid work permit
- Activity schedule signed by the contract manager.

2) **Payroll Transfer**

PUBLIC

When downloaded from the document management system, this document is uncontrolled and the responsibility rests with the user to ensure it is in line with the authorized version on the system. No part of this document may be reproduced without the expressed consent of the copyright holder, Eskom Holdings SOC Ltd, Reg. No 2002/015527/30.

In this approach, the employee's contract with the overseas employer will be suspended and the specialist takes up a local contract with the local company. The remuneration is then **ZAR** based, the overseas employer is unable to provide the foreign invoice because the employment with the specialist is suspended this methodology is usually favoured for long term engagement. There is no foreign commitment, and the contract will be in ZAR.

PART 2: EXCHANGE RATES

The tenderer shall use the exchange rate as at 12H00 on the date of the advertisement of the tender. The source of the exchange rates shall be the South African Reserve Bank (www.resbank.co.za) Please note that the tenderer is required to submit proof of the SARB rate/s used.

Date of advertisement of tender:	
Closing date of tender:	
Name of tenderer:	
Full names of authorised signatory:	
Signature:	
Date of signature:	

ANNEXURE G1

SBD 6.2

DECLARATION CERTIFICATE FOR LOCAL PRODUCTION AND CONTENT FOR DESIGNATED SECTORS

This Standard Bidding Document (SBD) must form part of all bids invited. It contains general information and serves as a declaration form for local content (local production and local content are used interchangeably).

Before completing this declaration, bidders must study the General Conditions, Definitions, Directives applicable in respect of Local Content as prescribed by the dtic, the South African Bureau of Standards (SABS) approved technical specification number SATS 1286:2011 (Edition 1) and the Guidance on the Calculation of Local Content together with the Local Content Declaration Templates [Annex C (Local Content Declaration: Summary Schedule), D (Imported Content Declaration: Supporting Schedule to Annex C) and E (Local Content Declaration: Supporting Schedule to Annex C)].

1. General Conditions

- 1.1. Dtic makes provision for the promotion of local production and content.
- 1.2. Dtic prescribes that in the case of designated sectors, organs of state must advertise such tenders with the specific bidding condition that only locally produced or manufactured goods, with a stipulated minimum threshold for local production and content will be considered.

PUBLIC

When downloaded from the document management system, this document is uncontrolled and the responsibility rests with the user to ensure it is in line with the authorized version on the system. No part of this document may be reproduced without the expressed consent of the copyright holder, Eskom Holdings SOC Ltd, Reg. No 2002/015527/30.

- 1.3. A person awarded a contract in relation to a designated sector, may not sub-contract in such a manner that the local production and content of the overall value of the contract is reduced to below the stipulated minimum threshold.
- 1.4. The local content (LC) expressed as a percentage of the bid price must be calculated in accordance with the SABS approved technical specification number SATS 1286: 2011 as follows:

$$LC = [1 - x / y] * 100$$

Where:

x is the imported content in Rand

y is the bid price in Rand excluding value added tax (VAT)

Prices referred to in the determination of x must be converted to Rand (ZAR) by using the exchange rate published by South African Reserve Bank (SARB) at 12:00 on the date of advertisement of the bid as indicated in paragraph 4.1 below.

The SABS approved technical specification number SATS 1286:2011 is accessible on http://www.thedti.gov.za/industrial_development/ip.jsp at no cost.

- 1.5. A bid may be disqualified if this Declaration Certificate and the Annex C (Local Content Declaration: Summary Schedule) are not submitted at the stipulated deadlines.
- 2. The stipulated minimum threshold(s) for local production and content (refer to Annex A of SATS 1286:2011) for this bid is/are as follows:**

<u>Description of services, works or goods</u>	<u>Stipulated minimum threshold</u>
_____	_____ %
_____	_____ %
_____	_____ %

3. Does any portion of the goods or services offered have any imported content?

(Tick applicable box)

YES	<input type="checkbox"/>	NO	<input type="checkbox"/>
-----	--------------------------	----	--------------------------

- 3.1 If yes, the rate(s) of exchange to be used in this bid to calculate the local content as prescribed in paragraph 1.5 of the general conditions must be the rate(s) published by SARB for the specific currency at 12:00 on the date of advertisement of the bid.

The relevant rates of exchange information is accessible on www.reservebank.co.za

Indicate the rate(s) of exchange against the appropriate currency in the table below (refer to Annex A of SATS 1286:2011):

Currency	Rates of exchange
US Dollar	
Pound Sterling	
Euro	
Yen	

PUBLIC

When downloaded from the document management system, this document is uncontrolled and the responsibility rests with the user to ensure it is in line with the authorized version on the system. No part of this document may be reproduced without the expressed consent of the copyright holder, Eskom Holdings SOC Ltd, Reg. No 2002/015527/30.

Other	
-------	--

NB: Bidders must submit proof of the SARB rate (s) of exchange used.

4. Where, after the award of a bid, challenges are experienced in meeting the stipulated minimum threshold for local content, the dti must be informed accordingly in order for the dti to verify and in consultation with the AO/AA provided directives in this regard.

LOCAL CONTENT DECLARATION
(REFER TO ANNEX B OF SATS 1286:2011)

LOCAL CONTENT DECLARATION BY CHIEF FINANCIAL OFFICER OR OTHER LEGALLY RESPONSIBLE PERSON NOMINATED IN WRITING BY THE CHIEF EXECUTIVE OR SENIOR MEMBER/PERSON WITH MANAGEMENT RESPONSIBILITY (CLOSE CORPORATION, PARTNERSHIP OR INDIVIDUAL)

IN RESPECT OF BID NO.

ISSUED BY: (Procurement Authority / Name of Institution):
.....

NB

- 1 The obligation to complete, duly sign and submit this declaration cannot be transferred to an external authorized representative, auditor or any other third party acting on behalf of the bidder.
- 2 Guidance on the Calculation of Local Content is accessible on http://www.thdti.gov.za/industrial_development/ip.jsp.
- 3 Local Content Declaration Templates (Annex C, D and E) is attached to this Invitation to Tender and must be submitted at the stipulated deadline.
- 4 Bidders should first complete Declaration D. After completing Declaration D, bidders should complete Declaration E and then consolidate the information on Declaration C. **Declaration C should be submitted at the stipulated deadline of the bid in order to substantiate the declaration made in paragraph (c) below.** Declarations D and E should be kept by the bidders for verification purposes for a period of at least 5 years. The successful bidder is required to continuously update Declarations C, D and E with the actual values for the duration of the contract.

I, the undersigned, (full names),
do hereby declare, in my capacity as
of(name of bidder
entity), the following:

- (a) The facts contained herein are within my own personal knowledge.
- (b) I have satisfied myself that:
 - (i) the goods/services/works to be delivered in terms of the above-specified bid comply with the minimum local content requirements as specified in the bid, and as measured in terms of SATS 1286:2011; and
- (c) The local content percentage (%) indicated below has been calculated using the formula given in clause 3 of SATS 1286:2011, the rates of exchange indicated in

PUBLIC

When downloaded from the document management system, this document is uncontrolled and the responsibility rests with the user to ensure it is in line with the authorized version on the system. No part of this document may be reproduced without the expressed consent of the copyright holder, Eskom Holdings SOC Ltd, Reg. No 2002/015527/30.

paragraph 4.1 above and the information contained in Declaration D and E which has been consolidated in Declaration C:

Bid price, excluding VAT (y)	R
Imported content (x), as calculated in terms of SATS 1286:2011	R
Stipulated minimum threshold for local content (paragraph 3 above)	
Local content %, as calculated in terms of SATS 1286:2011	

If the bid is for more than one product, the local content percentages for each product contained in Declaration C shall be used instead of the table above. The local content percentages for each product has been calculated using the formula given in clause 3 of SATS 1286:2011, the rates of exchange indicated in paragraph 4.1 above and the information contained in Declaration D and E.

- (d) I accept that the Procurement Authority / Institution has the right to request that the local content be verified in terms of the requirements of SATS 1286:2011.
- (e) I understand that the awarding of the bid is dependent on the accuracy of the information furnished in this application. I also understand that the submission of incorrect data, or data that are not verifiable as described in SATS 1286:2011, may result in the Procurement Authority / Institution imposing any or all of the remedies as provided for in Regulation 9.1 of the Preferential Procurement Regulations, 2022 promulgated under the Preferential Policy Framework Act (PPPFA), 2000 (Act No. 5 of 2000).

SIGNATURE: _____ **DATE:** _____
WITNESS No. 1 _____ **DATE:** _____
WITNESS No. 2 _____ **DATE:** _____

[Annexure G2 – Local Content Declaration - Summary Schedule \(Annex C\)](#)



Adobe Acrobat Document

[Annexure G3 – Imports Declaration – Supporting Schedule to Annex C \(Annex D\)\)](#)



Adobe Acrobat Document

[Annexure G4 – Local Content Declaration – Supporting Schedule to Annex C \(Annex E\)](#)



Adobe Acrobat Document

PUBLIC

When downloaded from the document management system, this document is uncontrolled and the responsibility rests with the user to ensure it is in line with the authorized version on the system. No part of this document may be reproduced without the expressed consent of the copyright holder, Eskom Holdings SOC Ltd, Reg. No 2002/015527/30.

ANNEXURE H

SBD 1

**PART A
 INVITATION TO BID**

YOU ARE HEREBY INVITED TO BID FOR REQUIREMENTS OF THE (NAME OF DEPARTMENT/ PUBLIC ENTITY)					
BID NUMBER:		CLOSING DATE:		CLOSING TIME:	
DESCRIPTION					
BID RESPONSE DOCUMENTS MAY BE DEPOSITED IN THE BID BOX SITUATED AT (STREET ADDRESS)					
BIDDING PROCEDURE ENQUIRIES MAY BE DIRECTED TO			TECHNICAL ENQUIRIES MAY BE DIRECTED TO:		
CONTACT PERSON			CONTACT PERSON		
TELEPHONE NUMBER			TELEPHONE NUMBER		
FACSIMILE NUMBER			FACSIMILE NUMBER		
E-MAIL ADDRESS			E-MAIL ADDRESS		
SUPPLIER INFORMATION					
NAME OF BIDDER					
POSTAL ADDRESS					
STREET ADDRESS					
TELEPHONE NUMBER	CODE		NUMBER		
CELLPHONE NUMBER					
FACSIMILE NUMBER	CODE		NUMBER		
E-MAIL ADDRESS					
VAT REGISTRATION NUMBER					
SUPPLIER COMPLIANCE STATUS	TAX COMPLIANCE SYSTEM PIN:		OR	CENTRAL SUPPLIER DATABASE No:	MAAA
ARE YOU THE ACCREDITED REPRESENTATIVE IN SOUTH AFRICA FOR THE GOODS /SERVICES OFFERED?	<input type="checkbox"/> Yes <input type="checkbox"/> No [IF YES ENCLOSE PROOF]		ARE YOU A FOREIGN BASED SUPPLIER FOR THE GOODS/SERVICES OFFERED?		<input type="checkbox"/> Yes <input type="checkbox"/> No [IF YES, ANSWER THE QUESTIONNAIRE BELOW]
QUESTIONNAIRE TO BIDDING FOREIGN SUPPLIERS					
IS THE ENTITY A RESIDENT OF THE REPUBLIC OF SOUTH AFRICA (RSA)?				<input type="checkbox"/> YES <input type="checkbox"/> NO	
DOES THE ENTITY HAVE A BRANCH IN THE RSA?				<input type="checkbox"/> YES <input type="checkbox"/> NO	
DOES THE ENTITY HAVE A PERMANENT ESTABLISHMENT IN THE RSA?				<input type="checkbox"/> YES <input type="checkbox"/> NO	
DOES THE ENTITY HAVE ANY SOURCE OF INCOME IN THE RSA?				<input type="checkbox"/> YES <input type="checkbox"/> NO	

PUBLIC

When downloaded from the document management system, this document is uncontrolled and the responsibility rests with the user to ensure it is in line with the authorized version on the system. No part of this document may be reproduced without the expressed consent of the copyright holder, Eskom Holdings SOC Ltd, Reg. No 2002/015527/30.

IS THE ENTITY LIABLE IN THE RSA FOR ANY FORM OF TAXATION? YES NO
IF THE ANSWER IS "NO" TO ALL OF THE ABOVE, THEN IT IS NOT A REQUIREMENT TO REGISTER FOR A TAX COMPLIANCE STATUS SYSTEM PIN CODE FROM THE SOUTH AFRICAN REVENUE SERVICE (SARS) AND IF NOT REGISTER AS PER 2.3 BELOW.

PART B

TERMS AND CONDITIONS FOR BIDDING

1. BID SUBMISSION:
1.1. BIDS MUST BE DELIVERED BY THE STIPULATED TIME TO THE CORRECT ADDRESS. LATE BIDS WILL NOT BE ACCEPTED FOR CONSIDERATION.
1.2. ALL BIDS MUST BE SUBMITTED ON THE OFFICIAL FORMS PROVIDED (NOT TO BE RE-TYPED) OR IN THE MANNER PRESCRIBED IN THE BID DOCUMENT.
1.3. THIS BID IS SUBJECT TO THE PREFERENTIAL PROCUREMENT POLICY FRAMEWORK ACT, 2000 AND THE PREFERENTIAL PROCUREMENT REGULATIONS, THE GENERAL CONDITIONS OF CONTRACT (GCC) AND, IF APPLICABLE, ANY OTHER SPECIAL CONDITIONS OF CONTRACT.
1.4. THE SUCCESSFUL BIDDER WILL BE REQUIRED TO FILL IN AND SIGN A WRITTEN CONTRACT FORM (SBD7).
2. TAX COMPLIANCE REQUIREMENTS
2.1 BIDDERS MUST ENSURE COMPLIANCE WITH THEIR TAX OBLIGATIONS.
2.2 BIDDERS ARE REQUIRED TO SUBMIT THEIR UNIQUE PERSONAL IDENTIFICATION NUMBER (PIN) ISSUED BY SARS TO ENABLE THE ORGAN OF STATE TO VERIFY THE TAXPAYER'S PROFILE AND TAX STATUS.
2.3 APPLICATION FOR TAX COMPLIANCE STATUS (TCS) PIN MAY BE MADE VIA E-FILING THROUGH THE SARS WEBSITE WWW.SARS.GOV.ZA .
2.4 BIDDERS MAY ALSO SUBMIT A PRINTED TCS CERTIFICATE TOGETHER WITH THE BID.
2.5 IN BIDS, WHERE CONSORTIA / JOINT VENTURES / SUB-CONTRACTORS ARE INVOLVED; EACH PARTY MUST SUBMIT A SEPARATE TCS CERTIFICATE / PIN / CSD NUMBER.
2.6 WHERE NO TCS PIN IS AVAILABLE BUT THE BIDDER IS REGISTERED ON THE CENTRAL SUPPLIER DATABASE (CSD), A CSD NUMBER MUST BE PROVIDED.
2.7 NO BIDS WILL BE CONSIDERED FROM PERSONS IN THE SERVICE OF THE STATE, COMPANIES WITH DIRECTORS WHO ARE PERSONS IN THE SERVICE OF THE STATE, OR CLOSE CORPORATIONS WITH MEMBERS PERSONS IN THE SERVICE OF THE STATE."

NB: FAILURE TO PROVIDE / OR COMPLY WITH ANY OF THE ABOVE PARTICULARS MAY RENDER THE BID INVALID.

SIGNATURE OF BIDDER:

CAPACITY UNDER WHICH THIS BID IS SIGNED:
(Proof of authority must be submitted e.g. company resolution)

DATE:

PUBLIC

When downloaded from the document management system, this document is uncontrolled and the responsibility rests with the user to ensure it is in line with the authorized version on the system. No part of this document may be reproduced without the expressed consent of the copyright holder, Eskom Holdings SOC Ltd, Reg. No 2002/015527/30.

ANNEXURE I

SBD 6.1

PREFERENCE POINTS CLAIM FORM IN TERMS OF THE PREFERENTIAL PROCUREMENT REGULATIONS 2022

This preference form must form part of all tenders invited. It contains general information and serves as a claim form for preference points for specific goals.

NB: BEFORE COMPLETING THIS FORM, TENDERERS MUST STUDY THE GENERAL CONDITIONS, DEFINITIONS AND DIRECTIVES APPLICABLE IN RESPECT OF THE TENDER AND PREFERENTIAL PROCUREMENT REGULATIONS, 2022

1. GENERAL CONDITIONS

1.1 The following preference point systems are applicable to invitations to tender:

- the 80/20 system for requirements with a Rand value of up to R50 000 000 (all applicable taxes included); and
- the 90/10 system for requirements with a Rand value above R50 000 000 (all applicable taxes included).

1.2 To be completed by the organ of state

- a) The applicable preference point system for this tender is the **90/10** preference point system.
- b) The applicable preference point system for this tender is the **80/20** preference point system.
- c) Either the **90/10 or 80/20 preference point system** will be applicable in this tender. The **lowest/ highest** acceptable tender will be used to determine the accurate system once tenders are received.

1.3 Points for this tender (even in the case of a tender for income-generating contracts) shall be awarded for:

- (a) Price; and
- (b) Specific Goals.

1.4 To be completed by the organ of state:

The maximum points for this tender are allocated as follows:

	POINTS
PRICE	
SPECIFIC GOALS	
Total points for Price and SPECIFIC GOALS	100

PUBLIC

When downloaded from the document management system, this document is uncontrolled and the responsibility rests with the user to ensure it is in line with the authorized version on the system. No part of this document may be reproduced without the expressed consent of the copyright holder, Eskom Holdings SOC Ltd, Reg. No 2002/015527/30.

- 1.5 Failure on the part of a tenderer to submit proof or documentation required in terms of this tender to claim points for specific goals with the tender, will be interpreted to mean that preference points for specific goals are not claimed.
- 1.6 The organ of state reserves the right to require of a tenderer, either before a tender is adjudicated or at any time subsequently, to substantiate any claim in regard to preferences, in any manner required by the organ of state.

2. DEFINITIONS

- (a) **“tender”** means a written offer in the form determined by an organ of state in response to an invitation to provide goods or services through price quotations, competitive tendering process or any other method envisaged in legislation;
- (b) **“price”** means an amount of money tendered for goods or services, and includes all applicable taxes less all unconditional discounts;
- (c) **“rand value”** means the total estimated value of a contract in Rand, calculated at the time of bid invitation, and includes all applicable taxes;
- (d) **“tender for income-generating contracts”** means a written offer in the form determined by an organ of state in response to an invitation for the origination of income-generating contracts through any method envisaged in legislation that will result in a legal agreement between the organ of state and a third party that produces revenue for the organ of state, and includes, but is not limited to, leasing and disposal of assets and concession contracts, excluding direct sales and disposal of assets through public auctions; and
- (e) **“The Act”** means the Preferential Procurement Policy Framework Act, 2000 (Act No. 5 of 2000).

3. FORMULAE FOR PROCUREMENT OF GOODS AND SERVICES

3.1. POINTS AWARDED FOR PRICE

3.1.1 THE 80/20 OR 90/10 PREFERENCE POINT SYSTEMS

A maximum of 80 or 90 points is allocated for price on the following basis:

$$P_s = 80 \left(1 - \frac{P_t - P_{min}}{P_{min}} \right) \quad \text{or} \quad P_s = 90 \left(1 - \frac{P_t - P_{min}}{P_{min}} \right)$$

Where

- P_s = Points scored for price of tender under consideration
 P_t = Price of tender under consideration
 P_{min} = Price of lowest acceptable tender

3.2. FORMULAE FOR DISPOSAL OR LEASING OF STATE ASSETS AND INCOME GENERATING PROCUREMENT

3.2.1. POINTS AWARDED FOR PRICE

A maximum of 80 or 90 points is allocated for price on the following basis:

PUBLIC

When downloaded from the document management system, this document is uncontrolled and the responsibility rests with the user to ensure it is in line with the authorized version on the system. No part of this document may be reproduced without the expressed consent of the copyright holder, Eskom Holdings SOC Ltd, Reg. No 2002/015527/30.

$$P_s = 80 \left(1 + \frac{P_t - P_{max}}{P_{max}} \right) \quad \text{or} \quad P_s = 90 \left(1 + \frac{P_t - P_{max}}{P_{max}} \right)$$

Where

- Ps = Points scored for price of tender under consideration
- Pt = Price of tender under consideration
- Pmax = Price of highest acceptable tender

4. POINTS AWARDED FOR SPECIFIC GOALS

- 4.1. In terms of Regulation 4(2); 5(2); 6(2) and 7(2) of the Preferential Procurement Regulations, preference points must be awarded for specific goals stated in the tender. For the purposes of this tender the tenderer will be allocated points based on the goals stated in table 1 below as may be supported by proof/ documentation stated in the conditions of this tender:
- 4.2. In cases where organs of state intend to use Regulation 3(2) of the Regulations, which states that, if it is unclear whether the 80/20 or 90/10 preference point system applies, an organ of state must, in the tender documents, stipulate in the case of—
 - (a) an invitation for tender for income-generating contracts, that either the 80/20 or 90/10 preference point system will apply and that the highest acceptable tender will be used to determine the applicable preference point system: or
 - (b) any other invitation for tender, that either the 80/20 or 90/10 preference point system will apply and that the lowest acceptable tender will be used to determine the applicable preference point system,
 then the organ of state must indicate the points allocated for specific goals for both the 90/10 and 80/20 preference point system.

Table 1: Specific goals for the tender and points claimed are indicated per the table below.

(Note to organs of state: Where either the 90/10 or 80/20 preference point system is applicable, corresponding points must also be indicated as such.

Note to tenderers: The tenderer must indicate how they claim points for each preference point system.)

The specific goals allocated points in terms of this tender	Number of points allocated (90/10 system) (To be completed by	Number of points allocated (80/20 system) (To be completed	Number of points claimed (90/10 system) (To be completed by the tenderer)	Number of points claimed (80/20 system) (To be completed by the tenderer)

PUBLIC

When downloaded from the document management system, this document is uncontrolled and the responsibility rests with the user to ensure it is in line with the authorized version on the system. No part of this document may be reproduced without the expressed consent of the copyright holder, Eskom Holdings SOC Ltd, Reg. No 2002/015527/30.

	the Organ of state)	by the organ of state)		

DECLARATION WITH REGARD TO COMPANY/FIRM

4.3. Name of company/firm.....

4.4. Company registration number:

4.5. TYPE OF COMPANY/ FIRM

- Partnership/Joint Venture / Consortium
- One-person business/sole proprietor
- Close corporation
- Public Company
- Personal Liability Company
- (Pty) Limited
- Trust
- Non-Profit Company
- State Owned Company

[TICK APPLICABLE BOX]

4.6. I, the undersigned, who is duly authorised to do so on behalf of the company/firm, certify that the points claimed, based on the specific goals as advised in the tender, qualifies the company/ firm for the preference(s) shown and I acknowledge that:

- i) The information furnished is true and correct;
- ii) The preference points claimed are in accordance with the General Conditions as indicated in paragraph 1 of this form;
- iii) In the event of a contract being awarded as a result of points claimed as shown in paragraphs 1.4 and 4.2, the contractor may be required to furnish documentary proof to the satisfaction of the organ of state that the claims are correct;
- iv) If the specific goals have been claimed or obtained on a fraudulent basis or any of the conditions of contract have not been fulfilled, the organ of state may, in addition to any other remedy it may have –
 - (a) disqualify the person from the tendering process;
 - (b) recover costs, losses, or damages it has incurred or suffered as a result

PUBLIC

When downloaded from the document management system, this document is uncontrolled and the responsibility rests with the user to ensure it is in line with the authorized version on the system. No part of this document may be reproduced without the expressed consent of the copyright holder, Eskom Holdings SOC Ltd, Reg. No 2002/015527/30.

of that person's conduct;

- (c) cancel the contract and claim any damages which it has suffered as a result of having to make less favourable arrangements due to such cancellation;
- (d) recommend that the tenderer or contractor, its shareholders and directors, or only the shareholders and directors who acted on a fraudulent basis, be restricted from obtaining business from any organ of state for a period not exceeding 10 years, after the *audi alteram partem* (hear the other side) rule has been applied; and
- (e) forward the matter for criminal prosecution, if deemed necessary.

.....	
SIGNATURE(S) OF TENDERER(S)	
SURNAME AND NAME:
DATE:
ADDRESS:

PUBLIC

When downloaded from the document management system, this document is uncontrolled and the responsibility rests with the user to ensure it is in line with the authorized version on the system. No part of this document may be reproduced without the expressed consent of the copyright holder, Eskom Holdings SOC Ltd, Reg. No 2002/015527/30.

ANNEXURE J

SBD 4

TENDERER'S DISCLOSURE

1. PURPOSE OF THE FORM

Any person (natural or juristic) may make an offer or offers in terms of this invitation to tender / request for proposal. In line with the principles of transparency, accountability, impartiality, and ethics as enshrined in the Constitution of the Republic of South Africa and further expressed in various pieces of legislation, Eskom requires the tenderer to make this declaration in respect of the details required hereunder.

Where a person/s are listed in the Register for Tender Defaulters and / or the List of Restricted Suppliers, including Restriction by Eskom, that person will automatically be disqualified from the tender process.

2. TENDERER'S DECLARATION

2.1 Is the tenderer or any of its directors / trustees / shareholders / members / partners or any person having a controlling interest in the enterprise, employed by the state?

[YES/NO]

2.1.1 If so, furnish particulars of the names, individual identity numbers, and, if applicable, state employee numbers of sole proprietor/ directors / trustees / shareholders / members/ partners or any person having a controlling interest in the enterprise, in the table below.

Full Name	Identity Number	Name of State Institution

2.2 Do you, or any person connected with the tenderer, have a relationship with any person who is employed by the procuring institution?

PUBLIC

When downloaded from the document management system, this document is uncontrolled and the responsibility rests with the user to ensure it is in line with the authorized version on the system. No part of this document may be reproduced without the expressed consent of the copyright holder, Eskom Holdings SOC Ltd, Reg. No 2002/015527/30.

[YES/NO]

If so, furnish particulars:

.....
.....

2.3 Does the tenderer or any of its directors / trustees / shareholders / members / partners or any person having a controlling interest in the enterprise have any interest in any other related enterprise whether or not they are bidding for this contract?

[YES/NO]

If so, furnish particulars:

.....
.....

3. DECLARATION

I, the undersigned, (name)..... in submitting the accompanying tender, do hereby make the following statements that I certify to be true and complete in every respect: -

- 3.1 I have read and I understand the contents of this disclosure;
- 3.2 I understand that the accompanying tender will be disqualified if this disclosure is found not to be true and complete in every respect;
- 3.3 The tenderer has arrived at the accompanying tender independently from, and without consultation, communication, agreement or arrangement with any competitor. However, communication between partners in a joint venture or consortium will not be construed as collusive bidding.
- 3.4 There have been no consultations, communications, agreements or arrangements with any competitor regarding the quality, quantity, specifications, prices, including methods, factors or formulas used to calculate prices, market allocation, the intention or decision to submit or not to submit the tender, tendering with the intention not to win the tender and conditions or delivery particulars of the products or services to which this tender invitation relates.
- 3.5 The terms of the accompanying tender have not been, and will not be, disclosed by the tenderer, directly or indirectly, to any competitor, prior to the date and time of the official tender opening or of the awarding of the contract.
- 3.6 There have been no consultations, communications, agreements or arrangements made by the tenderer with any official of the procuring institution in relation to this procurement

PUBLIC

When downloaded from the document management system, this document is uncontrolled and the responsibility rests with the user to ensure it is in line with the authorized version on the system. No part of this document may be reproduced without the expressed consent of the copyright holder, Eskom Holdings SOC Ltd, Reg. No 2002/015527/30.

process prior to and during the bidding process except to provide clarification on the tender submitted where so required by the institution, and the tenderer was not involved in the drafting of the specifications or terms of reference for this tender.

- 3.7 I am aware that, in addition and without prejudice to any other remedy provided to combat any restrictive practices related to bids and contracts, tenders that are suspicious will be reported to the Competition Commission for investigation and possible imposition of administrative penalties in terms of section 59 of the Competition Act No 89 of 1998 and or may be reported to the National Prosecuting Authority (NPA) for criminal investigation and/or the tenderer maybe restricted from conducting business with the public sector for a period not exceeding ten (10) years in terms of the Prevention and Combating of Corrupt Activities Act No 12 of 2004 or any other applicable legislation.

I CERTIFY THAT THE INFORMATION FURNISHED IN PARAGRAPHS 1, 2 and 3 ABOVE IS CORRECT.

I ACCEPT THAT THE STATE MAY REJECT THE TENDER OR ACT AGAINST THE TENDERER IN TERMS OF PARAGRAPH 6 OF PFMA SCM INSTRUCTION 03 OF 2021/22 ON PREVENTING AND COMBATING ABUSE IN THE SUPPLY CHAIN MANAGEMENT SYSTEM SHOULD THIS DECLARATION PROVE TO BE FALSE.

.....
Signature	Date
.....
Position	Name of bidder

PUBLIC

When downloaded from the document management system, this document is uncontrolled and the responsibility rests with the user to ensure it is in line with the authorized version on the system. No part of this document may be reproduced without the expressed consent of the copyright holder, Eskom Holdings SOC Ltd, Reg. No 2002/015527/30.