



OVERBERG DISTRICT MUNICIPALITY

Closing Date: 12:00 Thursday, 23 May 2024

Bid No: Q20-2023/24

Bid Title: SUPPLY AND INSTALL NEW 2200L DIESEL TANK AT DIE DAM HOLIDAY RESORT WITH STAND

COMPANY NAME	<hr/> <hr/> <hr/>
-------------------------	-------------------

Initial

INDEX

DESCRIPTION	PAGE NUMBERS
Invitation to Bid – MBD 1	3 – 4
Advert	5
Bid Conditions and Information	6 – 12
Terms of Reference – TOR and Specifications	13 – 14
Details of Bidder	15
Previous Experience	16
Authority to sign	17 – 18
Compulsory Enterprise Questionnaire	19
Tax Compliance Status - MBD2 (Compulsory)	21
Pricing Schedule – MBD 3.1	22 – 23
Form of Offer and Acceptance	24 – 25
Declaration of Interest – MBD4 (Compulsory)	26 – 29
Responsiveness and Evaluation criteria	30 – 31
General Conditions of Contract – MBD5	32 – 42
Preference Points Claim Form in terms of the Preferential Procurement Regulations 2022 – MBD6.1	44 – 48
Sworn Affidavit – B-BBEE EXEMPTED MICRO ENTERPRISE MBD6.1(a)	51
Contract Form – Purchases of goods / works – MBD7.1	52 – 53
Declaration of bidders past supply chain management practices – MBD8	54 – 55
Notification of decision	56
Certificate of Independent Bid Determination – MBD9	57 – 59
Key Performance Indicators – MBD 16	60
Important documentation and information	61
Annexure A	62 – 63
Annexure B – Certificate for municipal services	64
Checklist for completeness of bid documentation	65

IMPORTANT

- Do not dismember this Bid Document (do not take it apart).
All other documents of your submission must be attached behind this Bid Document unless stated otherwise.
- The bidder must initial every page of the bid document.
- Where requested witnesses must sign the document. Failure to do this may invalidate your bid.

Initial

- The checklist at the back of the bid document must be completed and adhered to.

MBD 1

**PART A
INVITATION TO BID**

YOU ARE HEREBY INVITED TO BID FOR REQUIREMENTS OF THE OVERBERG DISTRICT MUNICIPALITY					
BID NUMBER:	Q20-2023/24	CLOSING DATE:	Thursday, 23 May 2024	CLOSING TIME:	12h00
DESCRIPTION	SUPPLY AND INSTALL NEW 2200L DIESEL TANK AT DIE DAM HOLIDAY RESORT WITH STAND AT DIE DAM HOLIDAY RESORT				
THE SUCCESSFUL BIDDER WILL BE REQUIRED TO FILL IN AND SIGN A WRITTEN CONTRACT FORM (MBD7).					
BID RESPONSE DOCUMENTS MAY BE DEPOSITED IN THE BID BOX SITUATED AT (STREET ADDRESS)					
OVERBERG DISTRICT MUNICIPALITY					
26 Long Street					
Bredasdorp					
7280					
SUPPLIER INFORMATION					
NAME OF BIDDER					
POSTAL ADDRESS					
STREET ADDRESS					
TELEPHONE NUMBER	CODE		NUMBER		
CELLPHONE NUMBER					
FACSIMILE NUMBER	CODE		NUMBER		
E-MAIL ADDRESS					
VAT REGISTRATION NUMBER					
TAX COMPLIANCE STATUS	TCS PIN:		CSD No:		
B-BBEE STATUS LEVEL VERIFICATION CERTIFICATE [TICK APPLICABLE BOX]	<input type="checkbox"/> Yes <input type="checkbox"/> No		B-BBEE STATUS LEVEL SWORN AFFIDAVIT	<input type="checkbox"/> Yes <input type="checkbox"/> No	
[A B-BBEE STATUS LEVEL VERIFICATION CERTIFICATE/ SWORN AFFIDAVIT (FOR EMES & QSEs) MUST BE SUBMITTED IN ORDER TO QUALIFY FOR PREFERENCE POINTS FOR B-BBEE]					
ARE YOU THE ACCREDITED REPRESENTATIVE IN SOUTH AFRICA FOR THE GOODS /SERVICES /WORKS OFFERED?	<input type="checkbox"/> Yes <input type="checkbox"/> No [IF YES ENCLOSE PROOF]		ARE YOU A FOREIGN BASED SUPPLIER FOR THE GOODS /SERVICES /WORKS OFFERED?	<input type="checkbox"/> Yes <input type="checkbox"/> No [IF YES, ANSWER PART B:3]	
TOTAL NUMBER OF ITEMS OFFERED			TOTAL BID PRICE	R	
SIGNATURE OF BIDDER		DATE		
CAPACITY UNDER WHICH THIS BID IS SIGNED					
BIDDING PROCEDURE ENQUIRIES MAY BE DIRECTED TO:			TECHNICAL INFORMATION MAY BE DIRECTED TO:		
DEPARTMENT	Supply Chain Management		DEPARTMENT	Die Dam Holiday Resort	
CONTACT PERSON	Mr. J Harmse		CONTACT PERSON	Ms. C Cloete	
TELEPHONE NUMBER	028 425 1157, ext. 220		TELEPHONE NUMBER	028 425 1157, ext. 313	
E-MAIL ADDRESS	jharmse@odm.org.za		E-MAIL ADDRESS	ccloete@odm.org.za	

Initial

TERMS AND CONDITIONS FOR BIDDING

1. BID SUBMISSION:	
1.1.	BIDS MUST BE DELIVERED BY THE STIPULATED TIME TO THE CORRECT ADDRESS. LATE BIDS WILL NOT BE ACCEPTED FOR CONSIDERATION.
1.2.	ALL BIDS MUST BE SUBMITTED ON THE OFFICIAL FORMS PROVIDED – (NOT TO BE RE-TYPED) OR ONLINE
1.3.	THIS BID IS SUBJECT TO THE PREFERENTIAL PROCUREMENT POLICY FRAMEWORK ACT AND THE PREFERENTIAL PROCUREMENT REGULATIONS, 2022, THE GENERAL CONDITIONS OF CONTRACT (GCC), OVERBERG DISTRICT MUNICIPALITY'S SUPPLY CHAIN MANAGEMENT POLICY AND, IF APPLICABLE, ANY OTHER SPECIAL CONDITIONS OF CONTRACT
2. GENERAL	
2.1	BID DOCUMENTS CAN BE OBTAINED DURING OFFICE HOURS FROM MONDAY – THURSDAY: 8:00 – 13:00 AND 13:30 – 16:30, TUESDAYS: 8:00 – 13:00 AND 13:30 – 16:00 FROM THE OVERBERG DISTRICT MUNICIPALITY, SUPPLY CHAIN MANAGEMENT UNIT, 11 RECREATION STREET, BREDASDORP.
2.2	TELEPHONIC, FACSIMILE, ELECTRONIC/EMAILED BIDS, UNLESS STATED OTHERWISE, WILL NOT BE ACCEPTED FOR CONSIDERATION.
2.3	THE LOWEST OR ANY BID SHALL NOT NECESSARILY BE ACCEPTED AND THE COUNCIL RESERVES THE RIGHT TO ACCEPT ANY PART OF THE BID.
2.4	ALL BIDS MUST BE ACCOMPANIED BY A COPY OF THE BUSINESS REGISTRATION DOCUMENTS.
3. TAX COMPLIANCE REQUIREMENTS	
3.1	BIDDERS MUST ENSURE COMPLIANCE WITH THEIR TAX OBLIGATIONS.
3.2	BIDDERS ARE REQUIRED TO SUBMIT THEIR UNIQUE PERSONAL IDENTIFICATION NUMBER (PIN) ISSUED BY SARS TO ENABLE THE ORGAN OF STATE TO VIEW THE TAXPAYER'S PROFILE AND TAX STATUS.
3.3	APPLICATION FOR THE TAX COMPLIANCE STATUS (TCS) CERTIFICATE OR PIN MAY ALSO BE MADE VIA E-FILING. IN ORDER TO USE THIS PROVISION, TAXPAYERS WILL NEED TO REGISTER WITH SARS AS E-FILERS THROUGH THE WEBSITE WWW.SARS.GOV.ZA.
3.4	FOREIGN SUPPLIERS MUST COMPLETE THE PRE-AWARD QUESTIONNAIRE IN PART B:4.
3.5	BIDDERS MAY ALSO SUBMIT A PRINTED TCS CERTIFICATE TOGETHER WITH THE BID.
3.6	IN BIDS WHERE CONSORTIA / JOINT VENTURES / SUB-CONTRACTORS ARE INVOLVED; EACH PARTY MUST SUBMIT A SEPARATE TCS CERTIFICATE / PIN / CSD NUMBER.
3.7	WHERE NO TCS IS AVAILABLE BUT THE BIDDER IS REGISTERED ON THE CENTRAL SUPPLIER DATABASE (CSD), A CSD NUMBER MUST BE PROVIDED.
4. QUESTIONNAIRE TO BIDDING FOREIGN SUPPLIERS	
4.1	IS THE ENTITY A RESIDENT OF THE REPUBLIC OF SOUTH AFRICA (RSA)? <input type="checkbox"/> YES <input type="checkbox"/> NO
4.2	DOES THE ENTITY HAVE A BRANCH IN THE RSA? <input type="checkbox"/> YES <input type="checkbox"/> NO
4.3	DOES THE ENTITY HAVE A PERMANENT ESTABLISHMENT IN THE RSA? <input type="checkbox"/> YES <input type="checkbox"/> NO
4.4	DOES THE ENTITY HAVE ANY SOURCE OF INCOME IN THE RSA? <input type="checkbox"/> YES <input type="checkbox"/> NO
4.5	IS THE ENTITY LIABLE IN THE RSA FOR ANY FORM OF TAXATION? <input type="checkbox"/> YES <input type="checkbox"/> NO
IF THE ANSWER IS "NO" TO ALL OF THE ABOVE, THEN IT IS NOT A REQUIREMENT TO REGISTER FOR A TAX COMPLIANCE STATUS SYSTEM PIN CODE FROM THE SOUTH AFRICAN REVENUE SERVICE (SARS) AND IF NOT REGISTER AS PER 3.3 ABOVE.	

**NB: FAILURE TO PROVIDE ANY OF THE ABOVE PARTICULARS MAY RENDER THE BID INVALID.
NO BIDS WILL BE CONSIDERED FROM PERSONS IN THE SERVICE OF THE STATE.**

SIGNATURE OF BIDDER:

CAPACITY UNDER WHICH THIS BID IS SIGNED:

DATE:

.....

.....

.....

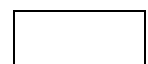

Initial



Q20-2023/24: SUPPLY AND INSTALL NEW 2200L DIESEL TANK AT DIE DAM HOLIDAY RESORT WITH STAND AT DIE DAM HOLIDAY RESORT

The Overberg District Municipality is currently awaiting quotations from suppliers to supply and install new hot water gas geysers and gas cylinders at ablution block 2, Uilenkraalsmond resort.

All bidders must submit proof of their valid CIDB registration with a minimum 1SL.

Enquiries regarding the specifications for this bid may be directed to Ms. C Cloete at 028 425 1157, ext. 313 or email: ccloete@odm.org.za.

Sealed envelope endorsed “**Q20-2023/24: SUPPLY AND INSTALL NEW 2200L DIESEL TANK AT DIE DAM HOLIDAY RESORT WITH STAND AT DIE DAM HOLIDAY RESORT**”, must be placed in the Bid box at the Municipal Offices, 26 Long Street, Bredasdorp, 7280 not later than **12:00** on **Thursday, 23 May 2024**. Quotations will be opened in public thereafter.

Quotations submitted by fax, e-mail, or received after the closing time and date shall not be accepted. Quotations may only be submitted on the prescribed official document.

Overberg District Municipality shall apply its Municipal Supply Chain Management Policy as adopted in terms of section 111 of the Local Government Municipal Finance Management Act, 2003 (Act No 56 of 2003) and the relevant regulations. Quotations will be evaluated according to the criteria and weight of the 80/20 preferential procurement system. Bidders must submit a valid Tax Compliance status PIN, issued by the South African Revenue Services.

The Overberg District Municipality complies with the Protection of Personal Information Act, Act 4 of 2013 (POPIA). Bidders agree that their personal information may be recorded and processed by the municipality.

It is the prerogative of the municipality not to accept the lowest, a part of or any quotation at all.

**R BOSMAN
MUNICIPAL MANAGER**

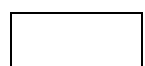

Initial

BID CONDITIONS AND INFORMATION	
1.	The Overberg District Municipality is not bound to accept the lowest, a part or any Bid at all.
2.	No Bids per fax, e-mail or late Bids will be valid.
3.	Only Bids submitted, which includes the attached Bid forms will be valid
4.	Payment will be made within 30 days of date of invoice.
5.	All Bids must be accompanied by a valid Tax Clearance Certificate or Tax Clearance Certificate PIN and a copy of the company's latest municipal account statement (not older than 3 months), or a copy of the lease agreement if the company is leasing the property. Bidders who are registered on the municipality's accredited supplier database and have attached the above documents to their application form does not need to submit these documents with their bid document.
6.	No alterations must be made to the Bid documents.
7.	Conditions as stipulated in the Supply Chain Management Policy of the Overberg District Municipality will apply.
8.	For evaluation purposes prospective suppliers need to attach an original or certified copy of the original of a SANAS approved BBEE verification certificate or an affidavit. (Not a photocopy of another certified copy)
9.	Bids must be placed in the Bid box as stipulated in the advertisement.
10.	All requested relevant and/or additional documentation such as Compliance Certificates, professional registration, artisan qualification, etc., must be submitted with the bid document. Please attach requested or additional documents at the back and not in the page sequence.
11.	Bidders must have their own transport (if applicable).
12.	Bidders must arrange their own accommodation (if applicable).
13. Agreement	The successful bidder will be expected to sign the Contract Form MBD 7.1 (Part 1) of this Bid documents within 30 days of the date of notification by the Overberg District Municipality that his/her bid has been accepted.
14. Completion of Bid Documents	<p>(a) The original bid document must be completed fully in black ink (handwritten or typed) and signed by the authorised signatory to validate the proposal. We do not accept any electronic signatures. All the pages must be initialled by the authorised signatory (not electronically). Failure to do so may result in the invalidation of the bid which will result in the bid being non-responsive.</p> <p>(b) Bid documents may not be retyped or altered in any way. The complete Bid document must be returned. Missing pages will result in disqualification of the bid.</p> <p>(c) Any bid document received with correction fluid (Tippex) corrections shall be disqualified.</p>
15. Alteration or Qualification of Bid	No unauthorised alteration of this set of bid documents will be allowed. Any unauthorised alteration will disqualify the proposal automatically. Any ambiguity must be cleared with the contact person for the bid before the closure date.
16. Authorised Signatory	<p>(a) The Resolution taken by the Board of Directors, members, partners or trustees authorising the representative to submit this bid on the bidder's behalf must be attached to the bid document on submission of the Bid.</p> <p>(b) A bid shall be eligible for consideration only if it bears the signature of the bidder or of some person duly and lawfully authorized to sign it for and on behalf of the bidder.</p> <p>(c) If the resolution does not accompany the Bid of the successful bidder, the Municipality reserves the right to obtain such document after the closing date to verify that the signatory is in order. If no such document can be obtained within a period as specified by the Municipality, the bid will be disqualified.</p>
17. Submission of Bid	<p>(a) The bid must be put in a sealed envelope, or envelopes when the two-envelope system is specified, clearly marked with the bid number, title as well as closing date and time and placed in the Tender Box at the Overberg District Municipality by not later than 12h00 on 23 May 2024.</p> <p>(b) Faxed, e-mailed and late bids will not be accepted. Bids may be delivered by hand, by courier, or posted at</p>

Initial

the bidder's risk and must be received by the deadline specified above, irrespective of how they are sent or delivered.

- (c) Bids received via courier services must be submitted in time and deposited into the Bid box by the courier services. Officials may not deposit bids into the bid box on behalf of the courier services and the Municipality accepts no responsibility for late delivery by courier services or for delivery at the wrong address.
- (d) Bids that are deposited in the incorrect box or late Bids will not be considered.

18. Opening, Recording and Publications of Bids Received

- (a) Bids will be opened in public immediately after the bid closure date, or at such time as specified in the bid documents. If requested by any bidder present, the names of the bidders, and if practical the total amount of each bid and of any alternative bids will be read out aloud.

19. Tax Compliance Status Pin Issued (TCS)

- (a) All bids must be accompanied by a valid Tax Compliance Status Pin Issued unless the Municipality has a valid TCS of the bidder on record. The onus is on the bidder to ensure that the Overberg District Municipality has a TCS on record and obtain confirmation from the Supply Chain Management Unit of the Overberg District Municipality.
- (b) Bids not supported by a valid Tax Compliance Status Pin Issued, either as an attachment to the bid documents or on record in the case of suppliers registered on the Supplier Database of the Overberg District Municipality will be invalidated.
- (c) In bids where consortia/joint ventures/sub-contractors are involved; each partner must submit a separate valid Tax Compliance Status Pin Issued.

20. Evaluation of Bids

Bids will be evaluated in terms of their responsiveness to the Bid specifications and requirements as well as such additional criteria as set out in the Bid document. Bidders must ensure that they adhere to the Responsiveness and Evaluation criteria (Page 30 – 31). The 80/20 preference points system will apply, where the 80 points will be used for price and the 20 points are awarded to the bidder for specific goals, see MBD 6.1.

21. Acceptance or Rejection of a Bid

The Overberg District Municipality reserves the right to withdraw any invitation to submit a bid and/or to re-advertise or to reject any bid or to accept any Bid in whole or a part of it. The Overberg District Municipality does not bind itself to accepting the lowest bid or the bid scoring the highest points.

The Municipality reserves the right to accept more than one bid (in the event of several items being offered).

The Municipality reserves the right to award the bid per line item (in the event of several items being offered).

22. Registration on Accredited Supplier Database & Central Supplier Database (CSD)

It is expected of all prospective service providers who are not yet registered on the Overberg District Municipality's Accredited Supplier Database to register without delay on the prescribed form. The Overberg District Municipality reserves the right not to award proposals to prospective suppliers who are not registered on the Database. The municipality is not allowed to do any business with suppliers who are not registered on the CSD.

23. Site / Information Meetings

No site meeting

24. Stamp and Other Duties

The successful bidder will be liable for all duties and costs on legal documents resulting in the establishment of a contract and for the surety and retentions.

25. Language of Contract

The contract documents will be compiled in English and the English versions of all referred documents will be taken as applicable.

26. Procurement Policy

Bids will be awarded in accordance with the Municipality's Preferential Procurement Regulations Policy and the Preferential Procurement Policy Framework Act, No 5 of 2000.

Initial

<p>27. Expenses Incurred in Preparation of Bid The Overberg District Municipality shall not be liable for any expenses incurred in the preparation and submission of the bid.</p>
<p>28. Wrong Information Furnished Where a contract has been awarded on the strength of the information furnished by the bidder which, after the conclusion of the relevant agreement, is proved to have been incorrect, the Overberg District Municipality may, in addition to any other legal remedy it may have, recover from the contractor all costs, losses or damages incurred or sustained by the Municipality because of the award of the contract.</p>
<p>29. Validity Period Bids shall remain valid and available for ninety (90) days calculating from the closing date as advertised for the bid, for acceptance, or non-acceptance by the Municipality. The bidder undertakes not to withdraw, or alter, the Bid during this period.</p>
<p>30. General and Special Conditions of Contract The General Conditions of Contract as well as any Special Conditions of Contract that may form part of this set of bid documents will be applicable to this bid in addition to the conditions of bid.</p>
<p>31. Municipal Rates, Taxes and Charges Any bidder who is or whose directors are in arrears with their municipal rates and taxes or municipal charges due to the Overberg District Municipality or any of its entities for more than three months and have not made an arrangement for settlement of same before the bid closure date will be disqualified.</p>
<p>32. Contact with Municipality after Bid Closure Date Bidders shall not contact the Overberg District Municipality on any matter relating to their bid from the time of the opening of the bid to the time the contract is awarded. If a bidder wishes to bring additional information to the notice of the Overberg District Municipality, it should do so in writing to the Overberg District Municipality. Any effort by the firm to influence the Overberg District Municipality in the bid evaluation, bid comparison or contract award decisions may result in the rejection of the bid.</p>
<p>33. Extension of Contract The contract with the successful bidder may be extended should additional funds become available.</p>
<p>34. Past Practices The bid of any bidder may be rejected if that bidder or any of its directors have abused the municipality's supply chain management system or committed any improper conduct in relation to such system. The bid of any bidder may be rejected if it is or has been found that that bidder or any of its directors influenced or tried to influence any official or councillor with this or any past bid. The bid of any bidder may be rejected if it is or has been found that that bidder or any of its directors offered, promised, or granted any official or any of his/her close family members, partners or associates any reward, gift, favors, hospitality, or any other benefit in any improper way, with this or any past bid.</p>
<p>35. B-BBEE Contributor Certificate / Sworn Affidavit (a) Notice 29617 of 2007, amendment of the Code of Good Practice, published in Government Gazette No. 29617 on 9 February 2007 in terms of the Broad-Based Black Economic Empowerment Act (Act No.53 of 2003), inter alia determines that:</p> <ul style="list-style-type: none"> ▪ any enterprise with an annual Total Revenue of R5 million or less qualifies as an Exempted Micro-Enterprise, provided that sufficient evidence of qualification as an EME is certified in an auditor's certificate or similar certificate issued by an accounting officer or verifying agency. ▪ any enterprise with an annual Total Revenue of between R5 million and R35 million qualifies as a Qualifying Small Enterprise, provided that such a QSE must select any four of the seven Elements of B-BBEE for the purposes of measurement under the Qualifying Small Enterprise Scorecard contained in Code 800 of the Act. ▪ a Start-up Enterprise must be measured as an EME under this statement for the first year following its formation or incorporation. This provision applies regardless of the expected total revenue of such a start-up enterprise. In order to qualify as a start-up enterprise an independent confirmation of its status must

Initial

be provided and a QSE Scorecard must be submitted when Bidding for any contract.

BUT – in accordance with Notice 1019 - during a Transitional Period from October 2013 to April 2015, a Measured Entity may elect to use either the provisions contained in the Statement (1) issued on 9 February 2007 OR the Statement (2) issued on 11 October 2013 – thereafter all B-BBEE compliance measurements will be in accordance with Notice 1019 of 2013.

- (b) Notice 1019 of 2013, published in Government Gazette No. 36928 on 11 October 2013, whereby the revised Codes of Good Practice (the codes) was issued under section 9(1) of the Broad-Based Black Economic Empowerment Act (Act No.53 of 2003), inter alia determines that:
- any enterprise with an annual Total Revenue of R10 million or less qualifies as an Exempted Micro-Enterprise and is only required to obtain a sworn affidavit on an annual basis, confirming its Annual Total Revenue and Level of Black ownership.
 - a measured Entity with an annual Total Revenue of between R10 million and R50 million qualifies as a Qualifying Small Enterprise and is only required to obtain a sworn affidavit on an annual basis, confirming its Annual Total Revenue and Level of Black ownership.
 - a Start-up Enterprise must be measured as an EME under this statement for the first year following its formation or incorporation. This provision applies regardless of the expected total revenue of such a start-up enterprise. In order to qualify as a start-up enterprise an independent confirmation of its status must be provided and a QSE Scorecard must be submitted when Bidding for any contract above R10 million.
- (c) If the certificate was issued by a verification agency the following must be on the face of the certificate: SANAS logo, unique BVA number, must be an original certificate or certified copy of the original, **not a photo-copy of another certified copy**, the name and physical location of the bidder, the registration number and, where applicable, the VAT number of the bidder, the date of issue and date of expiry of the certificate, the certificate number for identification and reference, the scorecard that was used (for example EME, QSE or Generic), the name and / or logo of the Verification Agency, the certificate must be signed by the authorized person from the Verification Agency and the B-BBEE Status Level of Contribution obtained by the bidder.

If certificate was issued by an Auditor/ Accounting Officers:

The Accounting Officer's or Registered Auditor's letter head with full contact details, the Accounting Officer's or Registered Auditor's practice numbers, the name and the physical location of the bidder, the registration number and, where applicable, the VAT number of the bidder, the date of issue and date of expiry, the BBEE Status Level of Contribution obtained by the measured entity, the total black shareholding and total black female shareholding, the B-BBEE Status Level of Contribution obtained by the bidder and must be an original certificate or certified copy of the original, **not a photo-copy of another certified copy**, the name and physical location of the bidder, the registration number and, where applicable, the VAT number of the bidder, the date of issue and date of expiry of the certificate, the certificate number for identification and reference, the scorecard that was used (for example EME, QSE or Generic), the name and / or logo of the Verification Agency, the certificate must be signed by the authorized person from the Verification Agency and the B-BBEE Status Level of Contribution obtained by the bidder.

If the certificate was issued by registered auditors approved by IRBA:

Clearly identify the B-BBEE approved registered auditor by the auditor's individual registration number with IRBA and the auditor's logo, clearly record an approved B-BBEE Verification Certificate identification reference in the format required by the SASAE, reflect relevant information regarding the identity and location of the measured entity, identify the Codes of Good Practice or relevant Sector Codes applied in the determination of the scores, record the weighting points (scores) attained by the measured entity for each scorecard element, where applicable, and the measured entity's overall B-BBEE Status Level of Contribution, reflect that the B-BBEE Verification Certificate and accompanying assurance report issued to the measured entity is valid for 12 months from the date of issuance and reflect both the issuance and expiry date, and the B-BBEE Status Level of Contribution obtained by the bidder and must be an original certificate or a certified copy of the original, **not a photo-copy of another certified copy**.

FAILURE TO COMPLY WITH THE ABOVEMENTIONED WILL RESULT IN NO PREFERENCE POINTS BEING AWARDED

Initial

<p>36. Persons in the service of the state</p> <p>Any person, having a kinship with persons in the service of the state, including a blood relationship, may make an offer in terms of this invitation to bid. In view of possible allegations of favouritism, should the resulting bid, or part thereof, be awarded to persons connected with or related to persons in service of the state, it is required that the bidder or their authorised representative declare their position in relation to the evaluating/adjudicating authority and/or take an oath declaring his/her interest.</p>
<p>37. Standards</p> <p>The goods supplied or the services rendered shall conform to the standards mentioned in the bidding documents and specifications.</p>
<p>38. Information and Inspection</p> <p>The service provider shall not, without the District Municipality's prior written consent, disclose the agreement, or any provision thereof, or any specification, plan, drawing, pattern, sample, or information furnished by or on behalf of the District Municipality in connection therewith, to any person other than a person employed by the service provider in the performance of the agreement. Disclosure to any such employed person shall be made in confidence and shall extend only as far as may be necessary for purposes of such performance.</p> <p>The service provider shall permit the Overberg District Municipality to inspect the supplier's records relating to the performance of the service provider and to have them audited by auditors appointed by the Overberg District Municipality, if so, required by the Overberg District Municipality.</p>
<p>39. Governing Language</p> <p>The governing language shall be English. All correspondence and other documents pertaining to the agreement that is exchanged by the parties shall also be written in English.</p>
<p>40. Payments</p> <p>Payments shall be made by the Overberg District Municipality within thirty (30) calendar days of receiving the relevant invoice provided by the supplier. Payment will be made in Rand unless otherwise stipulated</p>
<p>41. Prices and Evaluation of bids</p> <p>Prices charged by the service provider for goods delivered and services performed under the contract shall not vary from the prices quoted by the service provider in this Bid.</p> <p>The Bidder will be liable to take out forward cover to barricade him/her against fluctuation of the exchange rate in the event of importing any component, related to the Bid, from a country dealing in currency other than that of South Africa.</p> <p>THIS BID WILL BE EVALUATED AND ADJUDICATED ACCORDING TO THE FOLLOWING:</p> <ul style="list-style-type: none"> • Relevant specifications • Value for money • Capability to execute the contract • PPPFA & associated regulations
<p>42. Termination for default</p> <p>The Overberg District Municipality, without prejudice to any other remedy for breach of contract, by written notice of default sent to the service provider, may terminate this agreement in whole or in part:</p> <p>If the service provider fails to deliver any or all of the goods within the period(s) specified in the agreement;</p> <p>If the service provider fails to perform any obligation(s) under the contract; or</p> <p>If the service provider in the judgment of the Overberg District Municipality, has engaged in corrupt or fraudulent practices in competing for or in executing the contract</p> <p>In the event that the Overberg District Municipality terminates the contract in whole or in part, the Overberg District Municipality may procure, upon such terms and in such manner as it deems appropriate, goods, works or services similar to those undelivered, and the service provider shall be liable to the Overberg District Municipality for any excess costs for such similar goods, works or services. However, the service provider shall continue performance of the contract to the extent not terminated.</p> <p>Where the Overberg District Municipality terminates the contract in whole or in part, the Overberg District Municipality may decide to impose a restriction penalty on the service provider by prohibiting such service provider</p>

Initial

from doing business with the public sector for a period not exceeding 10 years.

If the Overberg District Municipality intends imposing a restriction on a service provider or any person associated with the service provider, the service provider will be allowed a time period of not more than fourteen (14) days to provide reasons why the envisaged restriction should not be imposed. Should the service provider fail to respond within the stipulated fourteen (14) days the Overberg District Municipality may regard the service provider as having no objection and proceed with the restriction.

Any restriction imposed on any person by the Overberg District Municipality will, at the discretion of the Overberg District Municipality, also be applicable to any other enterprise or any partner, manager, director or other person who wholly or partly exercises or exercised or may exercise control over the enterprise of the first-mentioned person, and with which enterprise or person the first-mentioned person, is or was in the opinion of the Overberg District Municipality actively associated.

If a restriction is imposed, the Overberg District Municipality must, within five (5) working days of such imposition, furnish the National Treasury, with the following information:

- The name and address of the supplier and / or person restricted by the Overberg District Municipality;
- The date of commencement of the restriction;
- The period of restriction; and
- The reasons for the restriction

These details will be loaded in the National Treasury's central database of service provider or persons prohibited from doing business with the public sector.

If a court of law convicts a person of an offence as contemplated in sections 12 or 13 of the Prevention and Combating of Corrupt Activities Act, No. 12 of 2004, the court may also rule that such person's name be endorsed on the Register for Bid Defaulters. When a person's name has been endorsed on the Register, the person will be prohibited from doing business with the public sector for a period not less than five years and not more than 10 years. The National Treasury is empowered to determine the period of restriction and each case will be dealt with on its own merits. According to section 32 of the Act the Register must be open to the public. The Register can be perused on the National Treasury website.

43. Termination for Insolvency

The Overberg District Municipality may at any time terminate the contract by giving written notice to the service provider if the service provider becomes bankrupt or otherwise insolvent. In this event, termination will be without compensation to the service provider, provided that such termination will not prejudice or affect any right of action or remedy which has accrued or will accrue thereafter to the Overberg District Municipality

44. Settlement of Disputes

If any dispute or difference of any kind whatsoever arises between the Overberg District Municipality and the service provider in connection with or arising out of the contract, the parties shall make every effort to resolve amicably such dispute or difference by mutual consultation.

If, after thirty (30) days, the parties have failed to resolve their dispute or difference by such mutual consultation, then either the Overberg District Municipality or the service provider may give notice to the other party of their intention to commence with mediation. No mediation in respect of this matter may be commenced unless such notice is given to the other party.

Should it not be possible to settle a dispute by means of mediation, it may be settled in a South African court of law.

Notwithstanding any reference to mediation and/or court proceedings herein, the parties shall continue to perform their respective obligations under the contract unless they otherwise agree; and

The Overberg District Municipality shall pay the service provider any monies due for goods delivered and/or services rendered according to the prescripts of the contract.

45. POPIA Disclaimer

The Accounting Officer (Municipal Manager) undertakes that all personal and confidential information will be processed lawfully and in a reasonable manner that does not infringe the privacy of bidders/organisations as the data subject.

Initial

<p>The processing is necessary and complies with an obligation imposed by law on the municipality, the responsible party and the processing protects bidders' rights to effective service delivery. The Overberg District Municipality complies with the Protection of Personal Information Act, Act 4 of 2013 (POPIA).</p>
<p>46. Applicable Law The contract shall be interpreted in accordance with South African laws, unless otherwise specified.</p>
<p>47. Notices Every written acceptance of a bid and any other notices shall be posted to the service provider concerned by ordinary mail to the address furnished in his bid or to the address notified later by him in writing and such posting shall be deemed to be proper service of such notice. The time mentioned in the contract documents for performing any act after such aforesaid notice has been given, shall be reckoned from the date of posting of such notice.</p>
<p>48. Taxes and duties A service provider shall be entirely responsible for all taxes, duties, license fees, etc., of the contracted goods to the Overberg District Municipality. No contract shall be concluded with any Bidder whose tax matters are not in order. No contract shall be concluded with any Bidder whose municipal rates and taxes and municipal services charges are in arrears.</p>
<p>49. Value-added tax (VAT) on invoices Tax invoices are to comply with the requirements as contained in the Value Added Tax Act, 1991 (Act No 89 of 1991). The content of the invoice must contain information as prescribed by the Act. It is a requirement of this contract that the amount of value-added tax (VAT) must be shown clearly on each invoice. The amended Value Added Tax Act, 1991 (Act No 89 of 1991) requires that a Tax Invoice for supplies in excess of R3,000 should, in addition to the other required information, also disclose the VAT registration number of the recipient, with effect from 1 March 2005. The VAT registration number of the Overberg District Municipality is 4610114409.</p>
<p>50. Construction Industry Development Board (CIDB) (If applicable) When applicable, the bidder's CIDB registration number must be included with the Bid. The Municipality will verify the bidder's CIDB registration during the evaluation process.</p>

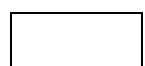

Initial

TERMS OF REFERENCE / SCOPE OF WORK - SPECIFICATIONS**PURPOSE**

The purpose of this quotation is to obtain quotations from suitable service providers for the **SUPPLY AND INSTALL NEW 2200L DIESEL TANK AT DIE DAM HOLIDAY RESORT WITH STAND AT DIE DAM HOLIDAY RESORT**

Specifications

See Annexure AA attached.

All bidders must submit proof of their valid CIDB registration with a minimum 1SL.

All prices must include VAT (if applicable)

Enquiries regarding the specifications can be directed to **Ms. C Cloete at 028 425 1157, ext. 313.**

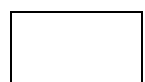

Initial

3. PRE-QUALIFICATION CRITERIA, SUB-CONTRACTING AND SOCIAL RESPONSIBILITY

- 3.1. The municipality reserves the right to prior to the award, request an inspection to establish that the standard of the material delivered by the manufacturer is according to the required quality. The successful supplier will be solely responsible for the provision of the material.
- 3.2. No sub-contracting between third parties of any kind will be allowed and will lead to non-compliance as per the criteria disclose under eligible criteria in paragraph 5.

4. EVALUATION AND ADJUDICATION

- 4.1. All items will be evaluated and awarded individually where applicable.
- 4.2. The estimated quantities (where applicable) will be used for evaluation purposes only and must not be seen as actual quantities to be supplied.
- 4.3. Two bidders will be identified for award, to ensure that, should the first bidder fail to perform according to the tender conditions, the second bidder will be used to render the service. The first bidder will be held responsible for the cost difference. The Municipality will not be obligated to place orders with the second bidder, when performance of the first bidders is of an acceptable standard.

5. ELIGIBILITY CRITERIA

The evaluation of formal quotations will be done in terms of compliance with the following criteria. Formal quotations that do not comply with all the criteria below will not be evaluated further.

Minimum General Requirements for all equipment/materials:	Please indicate with an "X" whether the offer complies with the requirements.			Reference (Supporting documents attached)
	YES	NO	Comment	
Will the item and service be provided by the bidder?				
Brochure with detailed specifications of the material and/or product manufacturer and code must be provided				
Lead time for delivery is 30 days after receiving the official order.				
Please indicate lead time.				

Initial

DETAILS OF BIDDER

Name of firm / entity / enterprise			
Trading as (if different from above)			
Postal address			
Physical address			
Contact Details of the Person Signing the Bid:	Name: _____ Telephone: _____ Fax: _____ Cellular Telephone: _____ e-mail address: _____		
Contact Details of the Senior Manager Responsible for Overseeing Contract Performance:	Name: _____ Telephone: _____ Fax: _____ Cellular Telephone: _____ e-mail address: _____		
Contact Details of the Bidder proposed Project Manager who will represent the Bidder in the implementation processes:	Name: _____ Telephone: _____ Fax: _____ Cellular Telephone: _____ e-mail address: _____		
Company Income Tax no.		Tax Clearance Certificate PIN	
VAT registration no.		CSD Registration Number	
Company registration no.		Date of Director's appointment	
Any other Registration applicable to this Industry			
Banking Details of Bidder	Name of Account holder: _____ Name of Bank: _____ Account Number: _____ Branch Code: _____		

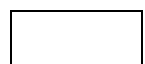

Initial

Previous Experience and References

This schedule is to determine the capability of the bidder to execute the contract.

Does your company have previous experience with regards to goods supplied or services rendered with reference to this Bid?

Yes	If yes, please elaborate using the table below & complete the signatory section at the bottom of the page
No	If no, please complete the signatory section at the bottom of the page

At least three (3) reference letters from companies with whom the service providers are/have conducted business relating to the terms of reference of this Bid must be included in the Bid document, together with the contact details of the references, alternatively reference letters must be submitted within a timeframe as to be determined by the Overberg District Municipality.

1. Company Name			
Description of project			
Contact person name			
Contact person telephone number			
Email Address			
Value of project			Year Completed
2. Company Name			
Description of project			
Contact person name			
Contact person telephone number			
Email Address			
Value of project			Year Completed
3. Company Name			
Description of project			
Contact person name			
Contact person telephone number			
Email Address			
Value of project			Year Completed

Signed at _____ On this _____ day of _____ 20____

As Witnesses: 1. _____ 2. _____

BIDDER (SUPPLIER) _____

Initial

AUTHORITY OF SIGNATORY

Indicate the status of the Bidder by ticking the appropriate box hereunder. The Bidder must complete the certificate set out below for the relevant category.

A Company	B Partnership	C Sole Proprietor	D Joint Venture	E Close Corporation

A. Certificate for company

I,, chairperson of the board of directors of, hereby confirm that by resolution of the board (copy attached) taken on 20..... Mr/Mrs acting in the capacity of, was authorised to sign all documents in connection with this Bid and any contract resulting from it on behalf of the company.

As witness

1.....
Chairman

2.....
Date

B. Certificate of partnership

We, the undersigned, being the key partners in the business trading as hereby authorise Mr/Mrs acting in the capacity of to sign all documents in connection with the Bid for contract and any contract resulting from it on our behalf.

NAME	ADDRESS	SIGNATURE	DATE

NOTE: This certificate is to be completed and signed by all of the key partners upon who rests the direction of the affairs of the Partnership as a whole.

C. Certificate for sole proprietor

I,, hereby confirm that I am the sole owner of the business trading as.....

As Witness:

1.....
Signature: Sole owner

2.....
Date

Initial

D. Certificate for Joint Venture

We, the undersigned, are submitting this Bid offer in Joint Venture and hereby authorise Mr/Mrs authorised signatory of the company acting in the capacity of lead partner, to sign all documents in connection with the Bid offer for contract and any other contract resulting from it on our behalf.

This authorisation is evidenced by the attached power of attorney signed by legally authorised signatories of all the partners to the Joint Venture.

NAME OF FIRM	ADDRESS	AUTHORISING SIGNATURE, NAME & CAPACITY
Lead partner		

E. Certificate for Close Corporation

We, the undersigned, being the key members in the business trading as hereby authorise Mr/Mrs acting in the capacity of to sign all documents in connection with the Bid for contract and any contract resulting from it on our behalf.

NAME	ADDRESS	SIGNATURE	DATE

NOTE: This certificate is to be complete and signed by all the key members upon whom rests the direction of the affairs of the Close Corporation as a whole.

Initial

COMPULSORY ENTERPRISE QUESTIONNAIRE

The following particulars **must** be furnished. In the case of a joint venture, separate enterprise questionnaires in respect of each partner must be completed and submitted.

Section 1: Enterprise details

Name of enterprise	
Contact Person	
Email	
Telephone	
Cell phone	
Fax	
Physical Address	
Postal Address	
Central supplier database registration number	MAAA

Section 2: Particulars of companies and close corporations

Company / Close Corporation registration number:	
---	--

Section 3: SARS information:

Tax reference number:	
VAT registration number, if any:	

Section 4: CIDB registration number: N/A

Section 5: Particulars of principles

Principle: means a natural person who is a partner in partnership, a sole proprietor, a director of a company established in terms of the Companies Act of 2008 (Act. No. 71 of 2008) a member of a close corporation registered in terms of the Close Corporation Act, 1984 (Act No.69 of 1984)

Full name of principal	Identity number*	Personal income tax number*

* Please complete and attach copies of Identity documents.

Section 6: Banking Details of companies and close corporations

Bank name and branch:

Bank account number:

Name of account holder:

Signed Date

Name Position

Bidder

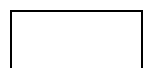

Initial

DOCUMENTS OF INCORPORATION (CK2)

The Bidder **must** attach to this page a copy of the certificate of incorporation of his/her company, close corporation or partnership. In the case of a joint venture between two or more firms, the Bidder shall attach a copy of the document of incorporation of the joint venture.

Signed Date

Name Position

Bidder

Initial

TAX COMPLIANCE STATUS

It is a condition of bid that the taxes of the successful bidder must be in order, or that satisfactory arrangements have been made with South African Revenue Service (SARS) to meet the bidder’s tax obligations.

- 1 In order to meet this requirement bidders are required to request their Tax Compliance Status which will include a unique PIN which you can provide to any third party (**if requested**) to enable them to verify your tax compliance status online via eFiling.
- 2 Request a TCC via eFiling which will give you the option to print the TCC or request a TCC at a SARS branch where a SARS agent will be able to print or email the TCC to you.
- 3 The Tax Compliance Status Requirements are also applicable to foreign bidders / individuals who wish to submit bids.
- 4 A **Tax Compliance Status** is a holistic view of your tax compliance level across all your registered tax types.
- 5 If your tax compliance status is compliant, the SARS agent will be able to print or email you your TCC to the registered email address which SARS has on record for you.
- 6 **Please note:** If your tax compliance status reflects that you are non-compliant, you will not receive a TCC until you have rectified your compliance.
- 7 The **Printed Tax Compliance status pin must** be submitted together with the bid. **Failure to submit** a Tax Compliance status pin **will result in the invalidation of the Bid.**
- 8 In bids where Consortia / Joint Ventures / Sub-contractors are involved; each party must submit a separate printed **Tax Compliance Status Pin**.
- 9 **Please note that not all government institutions and private organisations will be able to utilise the Tax Compliance Status (TCS) PIN at this stage and in such instances, you must supply a printed TCS. It is envisaged that the PIN will, in time, replace the paper TCS.**

	YES	NO
Is your company already registered on the Overberg District Municipality’s (ODM) Database?		
Have you confirmed this with the Supply Chain Management Department of ODM		
If yes, please provide ODM Database Supplier Number.		

As stated above, bidders must ensure that they are up to date with payments of taxes.

The bidder **must** attach to this page a **Tax Compliance status pin** as issued by the South African Revenue Service.

Failure to submit a Tax Compliance status pin **will result in the invalidation of the Bid.**

Signed Date

Name Position

Bidder

Initial

PRICING SCHEDULE

Name of Bidder: _____	Bid Number: Q20-2023/24
Closing Time: 12:00	Closing Date: 23 May 2024

OFFER TO BE VALID FOR 90 DAYS FROM THE CLOSING DATE OF BID.

PRICING INSTRUCTIONS:

- 1) For proper evaluation purposes it is essential that this specific pricing schedule be completed. Alternative pricing schedules will **NOT** be accepted.
- 2) Do **not** use correction fluid (Tippex). Any bid document received with correction fluid (Tippex) shall be disqualified. Draw a line across and initial all corrections.
- 3) State the rates and prices in Rand unless instructed otherwise in the Bid conditions.
- 4) All prices Tendered must include all expenses, disbursements, and costs (e.g. transport, etc.) that may be required for the execution of the Bidder's obligations in terms of the Contract, and shall cover the cost of all general risks, liabilities and obligations set forth or implied in the Contract as well as overhead charges and profit (in the event that the Bid is successful). All prices Tendered will be final and binding.
- 5) All pricing must include VAT. If any products/services will be rendered at no charge, in such an instance the price should be indicated on the pricing schedule as R0.00. If any products/services will not be Tendered on, in such an instance no quote should be indicated on the pricing schedule.
- 6) No upfront payments will be made. Payments to the Service Provider will only be affected after verification that goods supplied are according to the specifications.
- 7) Overberg District Municipality is not in a position to state exact quantities that will be purchased during the duration of the contract and the estimated number of units of each item, as indicated in the table below will be used for evaluation purposes, are based on historical trends but should not be used for Bid pricing purposes.
- 8) The appointed service provider must supply and deliver the items as required within the time frames as mutually agreed upon to the municipality. Should a service provider at any time fail to adhere to the specified delivery period, the Overberg District Municipality will be entitled to end the contract after written notices have been issued. Deliveries not complying with the product specifications and official order will be returned to the service provider at the service provider's expense as specified in paragraph 8.7 of the General Conditions of Contract.
- 9) The Municipality reserves the right to accept more than one quotation (in the event of several items being offered).
- 10) The Municipality reserves the right to award the quotation per line item (in the event of several items being offered).

Initial

**SUPPLY AND INSTALL NEW 2200L DIESEL TANK AT DIE DAM HOLIDAY RESORT WITH
STAND
AT DIE DAM HOLIDAY RESORT**

Description	Quantity	Total Price (incl. VAT)
Supply of a 2 200L Diesel tank	1	R
Installation (incl. Labour and all relevant costs)		R
Delivery / Transport to Die Dam Holiday Resort		R
TOTAL BID PRICE (Incl. VAT)		R

Address of Workstation / Office

The quantities, if applicable, as indicated in the pricing schedule are only estimates which will be used in order to evaluate the bid.

Required by:

Ms. C Cloete

- Does offer comply with specification? *YES/NO
- If not to specification, indicate deviation(s)
- *Delivery date: Firm/not firm

Note: All costs must be included in the total bid price and delivered to the prescribed destination.

Initial

COMPULSORY TO COMPLETE

BID NO: Q20-2023/24

**SUPPLY AND INSTALL NEW 2200L DIESEL TANK AT DIE DAM HOLIDAY RESORTWITH
STAND AT DIE DAM HOLIDAY RESORT**

FORM OF OFFER AND ACCEPTANCE

OFFER

The Employer, identified in the acceptance signature block, has solicited offers to enter into a contract for the procurement of:

**BID NO: Q20-2023/24 – SUPPLY AND INSTALL NEW 2200L DIESEL TANK AT DIE DAM
HOLIDAY RESORTWITH STAND AT DIE DAM HOLIDAY RESORT**

The Bid Supplier, identified in the acceptance signature block, has examined the documents listed in the Bid data and addenda thereto as listed in the returnable schedules, and by submitting this offer has accepted the conditions of Bid.

By the representative of the Bid Supplier, deemed to be duly authorized, signing this part of this form of offer and acceptance, the Bid Supplier offers to perform all of the obligations and liabilities of the contractor under the contract, including compliance with all its terms and conditions according to their true intent and meaning for an amount to be determined in accordance with the conditions of Bid identified in the Bid data.

**AS PER PRICING SCHEDULE MBD 3.1 (ALTERNATIVE PRICING SCHEDULES WILL NOT BE
ACCEPTED)**

This offer may be accepted by the employer by signing the acceptance part of this form of offer and acceptance and returning one copy of this document to the Bid supplier before the end of the period of validity stated in the Bid data, whereupon the Bid supplier becomes the party named as the contractor in the contract identified in the Bid data.

Signature(s)

Name(s)

Capacity

Company Name

Address

.....

.....

.....

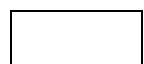

Initial

***NB: This form to be completed by the ODM.**

BID NO: Q20-2023/24

**SUPPLY AND INSTALL NEW 2200L DIESEL TANK AT DIE DAM HOLIDAY RESORT WITH
STAND AT DIE DAM HOLIDAY RESORT**

ACCEPTANCE

By signing this part of the form of offer and acceptance, the employer identified below accepts the Bid supplier's offer. In consideration thereof, the employer shall pay the Bid supplier the amount due in accordance with the conditions of quote identified in the Bid data. Acceptance of the Bid supplier's offer shall form an agreement between the employer and the Bid supplier upon the terms and conditions contained in this agreement and in the contract that is the subject of this agreement.

Notwithstanding anything contained herein, this agreement comes into effect on the date when the Bid supplier receives one fully completed original copy of this document, including the schedule of deviations (if any). Unless the Bid supplier within five working days of the date of such receipt notifies the employer in writing of any reason why he cannot accept the contents of this agreement, this agreement shall constitute a binding contract between the parties.

Signature(s)

Name(s)

Capacity

For the
Employer

.....
(Name and Address of Organization)

Date:

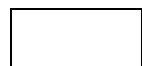

Initial

DECLARATION OF INTEREST

1. No bid will be accepted from persons in the service of the state¹.
2. Any person, having a kinship with persons in the service of the state, including a blood relationship, may make an offer or offers in terms of this invitation to bid. In view of possible allegations of favouritism, should the resulting bid, or part thereof, be awarded to persons connected with or related to persons in service of the state, it is required that the bidder or their authorised representative declare their position in relation to the evaluating/adjudicating authority
3. **In order to give effect to the above, the following questionnaire must be completed and submitted with the bid.**

3.1 Registered name of supplier	
3.2 Full name of representative	
3.3 Identity number of representative	
3.4 Position of representative occupied in the Company (owner, director, trustee, shareholder ²)	
3.5 Company registration number	
3.6 Tax reference number	
3.7 VAT registration number	
3.8 Central Supplier Database (CSD) Registration number	MAAA

¹MSCM Regulations: "in the service of the state" means to be –

- (a) a member of –
 - (i) any municipal council;
 - (ii) any provincial legislature; or
 - (iii) the national Assembly or the national Council of provinces;
- (b) a member of the board of directors of any municipal entity;
- (c) an official of any municipality or municipal entity;
- (d) an employee of any national or provincial department, national or provincial public entity or constitutional institution within the meaning of the Public Finance Management Act, 1999 (Act No.1 of 1999);
- (e) a member of the accounting authority of any national or provincial public entity; or
- (f) an employee of Parliament or a provincial legislature.

²Shareholder – means a person who owns shares in the company and is actively involved in the management of the company or business and exercise control over the company.

The names of all directors / trustees / shareholders members, their individual identity numbers and state employee numbers must be indicated in Annexure A (attached).

3.9 Have you (the owner) or any of the company’s directors, managers, principal shareholders, or stakeholders been in the service of the state for the past twelve months? **YES / NO**

3.9.1 If yes, furnish particulars.....

Initial

Section 3.9.1: Record of service of the state

Indicate by marking the relevant boxes with a cross, if any sole proprietor, partner in a partnership or director, manager, principal shareholder or stakeholder in a company or close corporation is currently or has been within the last 12 months in the service of any of the following:

- a member of any municipal council
- a member of any provincial legislature
- a member of the National Assembly or the National Council of Province
- a member of the board of directors of any municipal entity
- an official of any municipality or municipal entity
- an employee of any provincial department, national or provincial public entity or constitutional institution within the meaning of the Public Finance Management Act, 1999 (Act 1 of 1999)
- a member of an accounting authority of any national or provincial public entity
- an employee of Parliament or a provincial legislature

If any of the above boxes are marked, disclose the following: (insert separate page if necessary)

Name of sole proprietor, partner, director, manager, principal shareholder or stakeholder	Name of institution, public office, board or organ of state and position held	Status of service (tick appropriate column)	
		current	Within last 12 months

* Insert separate page if necessary

3.10 Do you have any relationship (family, friend, other) with persons in the service of the state and who may be involved with the evaluation and or adjudication of this bid?

YES / NO

3.10.1 If yes so, furnish particulars.....

3.11 Are you, aware of any relationship (family, friend, other) between a bidder and any persons in the service of the state who may be involved with the evaluation and or adjudication of this bid?

YES / NO

3.11.1 If yes so, furnish particulars.....

3.12

	YES	NO
3.12.1 Are you (the owner) or any of the company's directors, managers, principal shareholders, or stakeholders in service of the state?		
3.12.2 Are you (the owner) or any of the company's directors, managers, principal shareholders, or stakeholders an advisor or consultant contracted with an organ of state?		
3.12.3 Are you (the owner) or any of the company's directors, managers, principal shareholders, or stakeholders a member of any committee or board of an organ of state, e.g., audit committee, electrical board?		

Initial

3.12.2 If yes to any of the above, furnish particulars

.....

.....

.....

3.13 Are any spouse, child or parent of the company's directors, managers, principle shareholders or stakeholders in service of the state for the past twelve months? **YES / NO**

3.13.1 If yes so, furnish particulars

Name of the company's director / manager / principle shareholder and/or stakeholder	Full name of family member	Relationship	Name of the organization (Organ of State)	Capacity (Designation) in which family member is in at OOS*	Indicate current or the last date of service

*Organ of State

3.14 Do you (owner) or any of the directors, trustees, managers, principal shareholders, stakeholders; or any close family member, partner or associate of this company have any interest in any other company or business (Profit or Non-profit) whether or not they are bidding for this contract?

YES / NO

3.14.1 If yes, furnish particulars:

Name of the company's owner/director / manager / principal shareholder and/or stakeholder	Company name*	Central Supplier Database registration number (if registered)

*Name all companies, whether or not registered on CSD

* Insert separate page if necessary

3.14.2 Are you (owner) or any of the directors, trustees, managers, principal shareholders, stakeholders; or any close family member, partner, or associate of 3.14.1 employed at the Overberg District Municipality?

YES / NO

If yes, please furnish:

Name of the company's owner/director / manager / principal shareholder and/or stakeholder	Company name*	Department or employee number

*Name all companies, whether or not registered on CSD

* Insert separate page if necessary

Initial

4. Full details of directors / trustees / members / shareholders

Full Name	Identity Number	State Employee Number

.....
Signature

.....
Date

.....
Capacity

.....
Name of Bidder

<p align="center">COMMISSIONER OF OATHS</p> <p>Signed and sworn to before me at, _____ on</p> <p>this _____ day of _____ 20_____</p> <p>by the Deponent, who has acknowledged that he/she knows and understands the contents of this Affidavit, it is true and correct to the best of his/her knowledge and that he/she has no objection to taking the prescribed oath, and that the prescribed oath will be binding on his/her conscience.</p> <p>COMMISSIONER OF OATHS: -</p> <p>Name: _____</p> <p>Position: _____</p> <p>Address: _____</p> <p>_____</p> <p>Tel: _____</p> <p>Signature: _____</p> <p>_____</p>	<p>Apply official stamp of authority on this page:</p>
---	---

Initial

RESPONSIVENESS AND EVALUATION CRITERIA

NB: Overberg District Municipality may verify any information submitted in terms of this proposal and any information that is incorrect may result in that Bid being automatically disqualified and not considered further.

No bid will be considered by Overberg District Municipality unless it meets the following responsiveness criteria (for the bid to be considered responsive, the bid **must** meet the following requirements):

1. The bid must be properly received in a sealed envelope clearly indicating the description of the service and the bid number for which the bid is submitted.
2. The bid must be deposited in the relevant Bid box as indicated on the notice of the bid on or before the closing date and time of the bid. **Telephonic, facsimile, electronic/mailed and late bids will not be accepted.**
3. A Valid TCS PIN must be attached to the bid document. **Bidders who are registered on the municipality's accredited supplier database and attached a valid TCS PIN to their application form does not need to submit a tax clearance certificate with their bid document.**
4. The official bid document must be fully completed in indelible ink. Where information requested does not apply to the bidder and the space is left blank, it will be deemed to be not applicable.
5. **Completion of Bid Documents**
 - (a) The original bid document must be completed fully in black ink and signed by the authorized signatory to validate the proposal. **All the pages must be initialed by the authorized signatory.** Failure to do so may result in the invalidation of the bid which will result in the bid being non-responsive.
 - (b) Bid documents may not be retyped or altered in any way.
6. **Arithmetical Errors, Omissions and Discrepancies**
 - (a) Check responsive Bids for discrepancies between amounts in words and amounts in figures. Where there is a discrepancy between the amounts in figures and the amount in words, the amount in words shall govern.
 - (b) Check the highest ranked Bid or Bidder with the highest number of Bid evaluation points after the evaluation of Bid offers in accordance with paragraph 20 for:
 - i) the gross misplacement of the decimal point in any unit rate.
 - ii) omissions made in completing the pricing schedule or bills of quantities; or
 - iii) arithmetic errors in:
 - iv) line-item totals resulting from the product of a unit rate and a quantity in bills of quantities or schedules of prices; or
 - v) the summation of the prices.
 - (c) Notify the Bidder of all errors or omissions that are identified in the Bid offer and either confirm the Bid offer as Tendered or accept the corrected total of prices.
 - (d) Where the Bidder elects to confirm the Bid offer as Tendered, correct the errors as follows:
 - i) If bills of quantities or pricing schedules apply and there is an error in the line-item total resulting from the product of the unit rate and the quantity, the line-item total shall govern, and the rate shall be corrected.

Where there is an obviously gross misplacement of the decimal point in the unit rate, the line-item total as quoted shall govern, and the unit rate shall be corrected.

 - ii) Where there is an error in the total of the prices either as a result of other corrections required by this checking process or in the Bidder's addition of prices, the total of the prices shall govern, and the Bidder will be asked to revise selected item prices (and their rates if bills of quantities apply) to achieve the Tendered total of the prices.
7. All requested relevant and/or additional documentation such as Compliance Certificates, professional registration, artisan qualification, etc., must be submitted with the bid document.
Please indicate where in this document these attachments can be found.
8. The bidder must complete the previous experience schedule on page 15 of the bid document in order to prove its experience.
9. Annexure A (Authorization to deduct outstanding amounts) must be completed and signed. (Page 62 – 63)

Initial

10. Annexure B (certificate for municipal services and payments to service provider) must be completed and signed. Bidders must submit a certified statement signed by the bidder declaring that the bidder has no undisputed commitments for municipal services towards a municipality or other service provider in respect of which payment is overdue for more than 30 days. (Page 64)
11. The bidder must be in good standing to do business with the public sector in terms of Regulation 38 of the Supply Chain Management Regulations (Government Gazette 27636 of 30 May 2005).
12. If the entity submitting a bid is a Joint Venture or Consortium or Partnership, each party to that formation must submit all the above information.
13. The bidder must adhere to the Pricing Instructions (MBD 3.1) (Page 22 – 23). The quantities as indicated in the pricing schedule are only estimates which will be used in order to evaluate the bid. The unit prices as quoted above must remain fixed for the duration of the contract.
14. The Bidders Details must be provided
15. The necessary document authorized the Representative to sign and submit the bid on the bidder's behalf must be completed and signed. (Page 17 – 18)
16. The Form of Offer must be completed and signed by the bidder (Page 24).
17. The Declaration of Interests (MBD 4) must be completed and signed by the bidder. (Page 26 – 29)
18. The GCC (General Conditions of Contract) (MBD5) must be signed by the bidder (Page 32 – 42). Only the section applicable to the Bidder (Supplier).
19. MBD 8 (Declaration of bidder's past supply chain management practices) must be completed and signed
20. MBD 9 (Certificate of independent bid determination) must be completed and signed
21. The checklist at the back of the bid document must be completed and adhered to.
<p>EVALUATION AND ADJUDICATION CRITERIA OF BIDS</p> <ul style="list-style-type: none"> • All bids received shall be evaluated in terms of the Supply Chain Management Regulations, Preferential Procurement Policy Framework Act, SCM Policy and the Preferential Procurement Policy. • The Council reserves the right to accept all, some, or none of the bids submitted — either wholly or in part — and it is not obligated to accept the lowest bid. • Bids will be evaluated in terms of their responsiveness to the bid specifications and requirements as well as such additional criteria as set out in the bid documents. Bidders must ensure that they adhere to the Responsive and Evaluation Criteria (Page 30 – 31) • Quotations will also be evaluated and adjudicated according to the following criteria (if applicable): <ul style="list-style-type: none"> • Value for money • Capacity and capability of bidders to execute the contract. • Relevant specifications which could include the following: <ul style="list-style-type: none"> ◆ Eligibility criteria ◆ Technical requirements ◆ Pre-qualification criteria and social responsibility ◆ Functional criteria
<p>REGISTRATION ON ACCREDITED SUPPLIER DATABASE AND THE CENTRAL SUPPLIER DATABASE (CSD)</p> <ul style="list-style-type: none"> • It is expected of all prospective service providers who are not yet registered on the Overberg District Municipality's Accredited Supplier Database to register without delay on the prescribed form. The Overberg District Municipality reserves the right not to award proposals to prospective suppliers who are not registered on the Database. • Bidders must also be duly registered on the Central Supplier Database (CSD). Should you not be registered on the CSD, please self-register on www.csd.gov.za, for further assistance please contact csd@treasury.gov.za or 012 315 5509 • The municipality is not allowed to do any business with suppliers who are not registered on the CSD

Initial

 <p>OVERBERG DISTRICT MUNICIPALITY • DISTRIKSMUNISIPALITEIT • OORSPAAK WESITRIL</p>	<p>GENERAL CONDITIONS OF CONTRACT</p> <p>Made and entered into between</p> <p>OVERBERG DISTRICT MUNICIPALITY (Client)</p> <p>And</p> <p>_____</p> <p>(Supplier)</p>
<p>1. Definitions The following terms shall be interpreted as indicated:</p>	
"Closing time"	means the date and hour specified in the bidding documents for the receipt of bids.
"Contract"	means the written agreement entered into between the purchaser and the supplier, as recorded in the contract form signed by the parties, including all attachments and appendices thereto and all documents incorporated by reference therein.
"Contract price"	means the price payable to the supplier under the contract for the full and proper performance of his contractual obligations.
"Corrupt practice"	means the offering, giving, receiving, or soliciting of anything of value to influence the action of a public official in the procurement process or in contract execution.
"Countervailing duties"	are imposed in cases where an enterprise abroad is subsidized by its government and encouraged to market its products internationally.
"Country of origin"	means the place where the goods were mined, grown, or produced or from which the services are supplied. Goods are produced when, through manufacturing, processing, or substantial and major assembly of components, a commercially recognized new product results that is substantially different in basic characteristics or in purpose or utility from its components.
"Day"	means calendar day.
"Delivery"	means delivery in compliance of the conditions of the contract or order.
"Delivery ex stock"	means immediate delivery directly from stock on hand.
"Delivery into consignees store or to his site"	means delivered and unloaded in the specified store or depot or on the specified site in compliance with the conditions of the contract or order, the supplier bearing all risks and charges involved until the goods are so delivered and a valid receipt is obtained.
"Dumping"	occurs when a private enterprise abroad market its goods on own initiative in the RSA at lower prices than that of the country of origin and which have the potential to harm the local industries in the RSA.
"Force majeure"	means an event beyond the control of the supplier and not involving the supplier's fault or negligence and not foreseeable. Such events may include, but is not restricted to, acts of the purchaser in its sovereign capacity, wars or revolutions, fires, floods, epidemics, quarantine restrictions and freight embargoes.
"Fraudulent practice"	means a misrepresentation of facts to influence a procurement process or the execution of a contract to the detriment of any bidder and includes collusive practice among bidders (prior to or after bid submission) designed to establish bid prices at artificial non-competitive levels and to deprive the bidder of the benefits of free and open competition.
"GCC"	means the General Conditions of Contract.
"Goods"	means all the equipment, machinery, and/or other materials that the supplier is required to supply to the purchaser under the contract.

Initial

“Imported content”	means that portion of the bidding price represented by the cost of components, parts or materials which have been or are still to be imported (whether by the supplier or his subcontractors) and which costs are inclusive of the costs abroad, plus freight and other direct importation costs such as landing costs, dock dues, import duty, sales duty or other similar tax or duty at the South African place of entry as well as transportation and handling charges to the factory in the Republic where the goods covered by the bid will be manufactured.
“Local content”	means that portion of the bidding price, which is not included in the imported content provided that local manufacture does take place.
“Manufacture”	the production of products in a factory using labour, materials, components & machinery and includes other related value-adding activities.
“Order”	means an official written order issued for the supply of goods or works or the rendering of a service.
“Project site,”	where applicable, means the place indicated in bidding documents.
“Purchaser”	means the organization purchasing the goods.
“Republic”	means the Republic of South Africa.
“SCC”	means the Special Conditions of Contract.
“Services”	means those functional services ancillary to the supply of the goods, such as transportation and any other incidental services, such as installation, commissioning, provision of technical assistance, training, catering, gardening, security, maintenance and other such obligations of the supplier covered under the contract.
“Supplier”	means the successful bidder who is awarded the contract to maintain and administer the required and specified service(s) to the State.
“Tort”	means in breach of contract.
“Turnkey”	means a procurement process where one service provider assumes total responsibility for all aspects of the project and delivers the full end product / service required by the contract.
“Written” or “in writing”	means hand-written in ink or any form of electronic or mechanical writing.
2. Application	
2.1 These general conditions are applicable to all bids, contracts and orders including bids for functional and professional services (excluding professional services related to the building and construction industry), sales, hiring, letting and the granting or acquiring of rights, but excluding immovable property, unless otherwise indicated in the bidding documents.	
2.2 Where applicable, special conditions of contract are also laid down to cover specific goods, services or works.	
2.3 Where such special conditions of contract are in conflict with these general conditions, the special conditions shall apply.	
3. General	
3.1 Unless otherwise indicated in the bidding documents, the purchaser shall not be liable for any expense incurred in the preparation and submission of a bid. Where applicable a non-refundable fee for documents may be charged.	
3.2 Invitations to bid are usually published in locally distributed news media and on the municipality/municipal entity website.	
4. Standards	
4.1 The goods supplied shall conform to the standards mentioned in the bidding documents and specifications.	
5. Use of contract documents and information inspection	
5.1 The supplier shall not, without the purchaser’s prior written consent, disclose the contract, or any provision thereof, or any specification, plan, drawing, pattern, sample, or information furnished by or on behalf of the purchaser in connection	

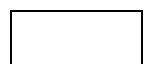

Initial

therewith, to any person other than a person employed by the supplier in the performance of the contract. Disclosure to any such employed person shall be made in confidence and shall extend only so far as may be necessary for purposes of such performance.

5.2 The supplier shall not, without the purchaser's prior written consent, make use of any document or information mentioned in GCC clause 5.1 except for purposes of performing the contract.

5.3 Any document, other than the contract itself mentioned in GCC clause 5.1 shall remain the property of the purchaser and shall be returned (all copies) to the purchaser on completion of the supplier's performance under the contract if so required by the purchaser.

5.4 The supplier shall permit the purchaser to inspect the supplier's records relating to the performance of the supplier and to have them audited by auditors appointed by the purchaser, if so required by the purchaser.

6. Patent Rights

6.1 The supplier shall indemnify the purchaser against all third-party claims of infringement of patent, trademark, or industrial design rights arising from use of the goods or any part thereof by the purchaser.

6.2 When a supplier developed documentation / projects for the municipality / municipal entity, the intellectual, copy and patent rights or ownership of such documents or projects will vest in the municipality / municipal entity.

7. Performance security

7.1 Within thirty (30) days of receipt of the notification of contract award, the successful bidder shall furnish to the purchaser the performance security of the amount specified in SCC.

7.2 The proceeds of the performance security shall be payable to the purchaser as compensation for any loss resulting from the supplier's failure to complete his obligations under the contract.

7.3 The performance security shall be denominated in the currency of the contract or in a freely convertible currency acceptable to the purchaser and shall be in one of the following forms:

- (a) a bank guarantee or an irrevocable letter of credit issued by a reputable bank located in the purchaser's country or abroad, acceptable to the purchaser, in the form provided in the bidding documents or another form acceptable to the purchaser; or
- (b) A cashier's or certified cheque.

7.4 The performance security will be discharged by the purchaser and returned to the supplier not later than thirty (30) days following the date of completion of the supplier's performance obligations under the contract, including any warranty obligations, unless otherwise specified.

8. Inspections, tests and analyses

8.1 All pre-bidding testing will be for the account of the bidder.

8.2 If it is a bid condition that goods to be produced or services to be rendered should at any stage be subject to inspections, tests and analyses, the bidder or contractor's premises shall be open, at all reasonable hours, for inspection by a representative of the purchaser or organization acting on behalf of the purchaser.

8.3 If there are no inspection requirements indicated in the bidding documents and no mention is made in the contract, but during the contract period it is decided that inspections shall be carried out, the purchaser shall itself make the necessary arrangements, including payment arrangements with the testing authority concerned.

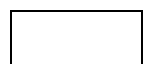

Initial

- 8.4 If the inspections, tests and analyses referred to in clauses 8.2 and 8.3 show the goods to be in accordance with the contract requirements, the cost of the inspections, tests and analyses shall be defrayed by the purchaser.
- 8.5 Where the goods or services referred to in clauses 8.2 and 8.3 do not comply with the contract requirements, irrespective of whether such goods or services are accepted or not, the cost in connection with these inspections, tests or analyses shall be defrayed by the supplier.
- 8.6 Goods and services which are referred to in clauses 8.2 and 8.3 and which do not comply with the contract requirements may be rejected.
- 8.7 Any contract goods may on or after delivery be inspected, tested or analysed and may be rejected if found not to comply with the requirements of the contract. Such rejected goods shall be held at the cost and risk of the supplier who shall, when called upon, remove them immediately at his own cost and forthwith substitute them with goods, which do comply with the requirements of the contract. Failing such removal, the rejected goods shall be returned at the suppliers cost and risk. Should the supplier fail to provide the substitute goods forthwith, the purchaser may, without giving the supplier further opportunity to substitute the rejected goods, purchase such goods as may be necessary at the expense of the supplier.
- 8.8 The provisions of clauses 8.4 to 8.7 shall not prejudice the right of the purchaser to cancel the contract on account of a breach of the conditions thereof, or to act in terms of Clause 22 of GCC.

9. Packing

- 9.1 The supplier shall provide such packing of the goods as is required to prevent their damage or deterioration during transit to their final destination, as indicated in the contract. The packing shall be sufficient to withstand, without limitation, rough handling during transit and exposure to extreme temperatures, salt and precipitation during transit, and open storage. Packing, case size weights shall take into consideration, where appropriate, the remoteness of the goods' final destination and the absence of heavy handling facilities at all points in transit.
- 9.2 The packing, marking, and documentation within and outside the packages shall comply strictly with such special requirements as shall be expressly provided for in the contract, including additional requirements, if any, and in any subsequent instructions ordered by the purchaser

10. Delivery and documents

- 10.1 Delivery of the goods and arrangements for shipping and clearance obligations, shall be made by the supplier in accordance with the terms specified in the contract.

11. Insurance

- 11.1 The goods supplied under the contract shall be fully insured in a freely convertible currency against loss or damage incidental to manufacture or acquisition, transportation, storage and delivery in the manner specified.

12. Transportation

- 12.1 Should a price other than an all-inclusive delivered price be required, this shall be specified.

13. Incidental Services

- 13.1 The supplier may be required to provide any or all of the following services, including additional services, if any:
- (a) Performance or supervision of on-site assembly and/or commissioning of the supplied goods;

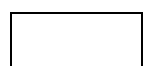

Initial

- (b) Furnishing of tools required for assembly and/or maintenance of the supplied goods;
- (c) Furnishing of a detailed operations and maintenance manual for each appropriate unit of the supplied goods;
- (d) Performance or supervision or maintenance and/or repair of the supplied goods, for a period of time agreed by the parties, provided that this service shall not relieve the supplier of any warranty obligations under this contract; and
- (e) Training of the purchaser's personnel, at the supplier's plant and/or on-site, in assembly, start-up, operation, maintenance, and/or repair of the supplied goods.

13.2 Prices charged by the supplier for incidental services, if not included in the contract price for the goods, shall be agreed upon in advance by the parties and shall not exceed the prevailing rates charged to other parties by the supplier for similar services.

14. Spare parts

14.1 As specified, the supplier may be required to provide any or all of the following materials, notifications, and information pertaining to spare parts manufactured or distributed by the supplier:

- (a) Such spare parts as the purchaser may elect to purchase from the supplier, provided that this election shall not relieve the supplier of any warranty obligations under the contract; and;
- (b) In the event of termination of production of the spare parts:
 - (i) Advance notification to the purchaser of the pending termination, in sufficient time to permit the purchaser to procure needed requirements; and
 - (ii) Following such termination, furnishing at no cost to the purchaser, the blueprints, drawings, and specifications of the spare parts, if requested

15. Warranty

15.1 The supplier warrants that the goods supplied under the contract are new, unused, of the most recent or current models, and that they incorporate all recent improvements in design and materials unless provided otherwise in the contract. The supplier further warrants that all goods supplied under this contract shall have no defect, arising from design, materials, or workmanship (except when the design and/or material is required by the purchaser's specifications) or from any act or omission of the supplier, that may develop under normal use of the supplied goods in the conditions prevailing in the country of final destination.

15.2 This warranty shall remain valid for twelve (12) months after the goods, or any portion thereof as the case may be, have been delivered to and accepted at the final destination indicated in the contract, or for eighteen (18) months after the date of shipment from the port or place of loading in the source country, whichever period concludes earlier, unless specified otherwise.

15.3 The purchaser shall promptly notify the supplier in writing of any claims arising under this warranty.

15.4 Upon receipt of such notice, the supplier shall, within the period specified and with all reasonable speed, repair or replace the defective goods or parts thereof, without costs to the purchaser.

15.5 If the supplier, having been notified, fails to remedy the defect(s) within the period specified, the purchaser may proceed to take such remedial action as may be necessary, at the supplier's risk and expense and without prejudice to any other rights which the purchaser may have against the supplier under the contract.

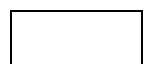

Initial

16. Payment

16.1 The method and conditions of payment to be made to the supplier under this contract shall be specified.

16.2 The supplier shall furnish the purchaser with an invoice accompanied by a copy of the delivery note and upon fulfilment of other obligations stipulated in the contract.

16.3 Payments shall be made promptly by the purchaser, but in no case later than thirty (30) days after submission of an invoice or claim by the supplier.

16.4 Payment will be made in Rand unless otherwise stipulated.

17. Prices

17.1 Prices charged by the supplier for goods delivered and services performed under the contract shall not vary from the prices quoted by the supplier in his bid, with the exception of any price adjustments authorized or in the purchaser's request for bid validity extension, as the case may be.

18. Variation orders

18.1 In cases where the estimated value of the envisaged changes in purchase does not vary more than 15% of the total value of the original contract, the contractor may be instructed to deliver the goods or render the services as such. In cases of measurable quantities, the contractor may be approached to reduce the unit price, and such offers may be accepted provided that there is no escalation in price.

19. Assignment

19.1 The supplier shall not assign, in whole or in part, its obligations to perform under the contract, except with the purchaser's prior written consent.

20. Subcontracts

20.1 The supplier shall notify the purchaser in writing of all subcontracts awarded under this contract if not already specified in the bid. Such notification, in the original bid or later, shall not relieve the supplier from any liability or obligation under the contract.

21. Delays in the supplier's performance

21.1 Delivery of the goods and performance of services shall be made by the supplier in accordance with the time schedule prescribed by the purchaser in the contract.

21.2 If at any time during performance of the contract, the supplier or its subcontractor(s) should encounter conditions impeding timely delivery of the goods and performance of services, the supplier shall promptly notify the purchaser in writing of the fact of the delay, its likely duration, and its cause(s). As soon as practicable after receipt of the supplier's notice, the purchaser shall evaluate the situation and may at his discretion extend the supplier's time for performance, with or without the imposition of penalties, in which case the extension shall be ratified by the parties by amendment of contract.

21.3 The right is reserved to procure outside of the contract small quantities or to have minor essential services executed if an emergency arises, the supplier's point of supply is not situated at or near the place where the goods are required, or the supplier's services are not readily available.



Initial

21.4 Except as provided under GCC Clause 25, a delay by the supplier in the performance of its delivery obligations shall render the supplier liable to the imposition of penalties, pursuant to GCC Clause 22, unless an extension of time is agreed upon pursuant to GCC Clause 22.2 without the application of penalties.

21.5 Upon any delay beyond the delivery period in the case of a goods contract, the purchaser shall, without cancelling the contract, be entitled to purchase goods of a similar quality and up to the same quantity in substitution of the goods not supplied in conformity with the contract and to return any goods delivered later at the supplier's expense and risk, or to cancel the contract and buy such goods as may be required to complete the contract and without prejudice to his other rights, be entitled to claim damages from the supplier.

22. Penalties

22.1 Subject to GCC Clause 25, if the supplier fails to deliver any or all of the goods or to perform the services within the period(s) specified in the contract, the purchaser shall, without prejudice to its other remedies under the contract, deduct from the contract price, as a penalty, a sum calculated on the delivered price of the delayed goods or unperformed services using the current prime interest rate calculated for each day of the delay until actual delivery or performance. The purchaser may also consider termination of the contract pursuant to GCC Clause 23.

23. Termination for default

23.1 The purchaser, without prejudice to any other remedy for breach of contract, by written notice of default sent to the supplier, may terminate this contract in whole or in part:

- (a) if the supplier fails to deliver any or all of the goods within the period(s) specified in the contract, or within any extension thereof granted by the purchaser pursuant to GCC Clause 21.2;
- (b) if the supplier fails to perform any other obligation(s) under the contract; or
- (c) if the supplier, in the judgement of the purchaser, has engaged in corrupt or fraudulent practices in competing for or in executing the contract.

23.2 In the event the purchaser terminates the contract in whole or in part, the purchaser may procure, upon such terms and in such manner, as it deems appropriate, goods, works or services similar to those undelivered, and the supplier shall be liable to the purchaser for any excess costs for such similar goods, works or services. However, the supplier shall continue performance of the contract to the extent not terminated.

23.3 Where the purchaser terminates the contract in whole or in part, the purchaser may decide to impose a restriction penalty on the supplier by prohibiting such supplier from doing business with the public sector for a period not exceeding 10 years.

23.4 If a purchaser intends imposing a restriction on a supplier or any person associated with the supplier, the supplier will be allowed a time period of not more than fourteen (14) days to provide reasons why the envisaged restriction should not be imposed. Should the supplier fail to respond within the stipulated fourteen (14) days the purchaser may regard the supplier as having no objection and proceed with the restriction.

23.5 Any restriction imposed on any person by the purchaser will, at the discretion of the purchaser, also be applicable to any other enterprise or any partner, manager, director or other person who wholly or partly exercises or exercised or

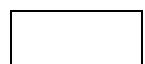

Initial

may exercise control over the enterprise of the first-mentioned person, and with which enterprise or person the first-mentioned person, is or was in the opinion of the purchaser actively associated.

23.6 If a restriction is imposed, the purchaser must, within five (5) working days of such imposition, furnish the National Treasury, with the following information:

- (i) The name and address of the supplier and / or person restricted by the purchaser;
- (ii) The date of commencement of the restriction
- (iii) The period of restriction; and
- (iv) The reasons for the restriction.

These details will be loaded in the National Treasury's central database of suppliers or persons prohibited from doing business with the public sector.

23.7. If a court of law convicts a person of an offence as contemplated in sections 12 or 13 of the Prevention and Combating of Corrupt Activities Act, No. 12 of 2004, the court may also rule that such person's name be endorsed on the Register for Bid Defaulters. When a person's name has been endorsed on the Register, the person will be prohibited from doing business with the public sector for a period not less than five years and not more than 10 years. The National Treasury is empowered to determine the period of restriction and each case will be dealt with on its own merits. According to section 32 of the Act the Register must be open to the public. The Register can be perused on the National Treasury website

24. Antidumping and countervailing duties and rights

24.1 When, after the date of bid, provisional payments are required, or anti-dumping or countervailing duties are imposed, or the amount of a provisional payment or anti-dumping or countervailing right is increased in respect of any dumped or subsidized import, the State is not liable for any amount so required or imposed, or for the amount of any such increase. When, after the said date, such a provisional payment is no longer required or any such anti-dumping or countervailing right is abolished, or where the amount of such provisional payment or any such right is reduced, any such favourable difference shall on demand be paid forthwith by the supplier to the purchaser or the purchaser may deduct such amounts from moneys (if any) which may otherwise be due to the supplier in regard to goods or services which he delivered or rendered, or is to deliver or render in terms of the contract or any other contract or any other amount which may be due to him.

25. Force Majeure

25.1 Notwithstanding the provisions of GCC Clauses 22 and 23, the supplier shall not be liable for forfeiture of its performance security, damages, or termination for default if and to the extent that his delay in performance or other failure to perform his obligations under the contract is the result of an event of force majeure.

25.2 If a force majeure situation arises, the supplier shall promptly notify the purchaser in writing of such condition and the cause thereof. Unless otherwise directed by the purchaser in writing, the supplier shall continue to perform its obligations under the contract as far as is reasonably practical and shall seek all reasonable alternative means for performance not prevented by the force majeure event.

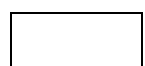

Initial

26. Termination for insolvency

26.1 The purchaser may at any time terminate the contract by giving written notice to the supplier if the supplier becomes bankrupt or otherwise insolvent. In this event, termination will be without compensation to the supplier, provided that such termination will not prejudice or affect any right of action or remedy, which has accrued or will accrue thereafter to the purchaser.

27. Settlement of Disputes

27.1 If any dispute or difference of any kind whatsoever arises between the purchaser and the supplier in connection with or arising out of the contract, the parties shall make every effort to resolve amicably such dispute or difference by mutual consultation.

27.2 If, after thirty (30) days, the parties have failed to resolve their dispute or difference by such mutual consultation, then either the purchaser or the supplier may give notice to the other party of his intention to commence with mediation. No mediation in respect of this matter may be commenced unless such notice is given to the other party.

27.3 Should it not be possible to settle a dispute by means of mediation, it may be settled in a South African court of law.

27.4 Notwithstanding any reference to mediation and/or court proceedings herein,

- (a) The parties shall continue to perform their respective obligations under the contract unless they otherwise agree; and
- (b) The purchaser shall pay the supplier any monies due the supplier for goods delivered and / or services rendered according to the prescripts of the contract.

28. Limitation of Liability

28.1 Except in cases of criminal negligence or wilful misconduct, and in the case of infringement pursuant to Clause 6;

- (a) The supplier shall not be liable to the purchaser, whether in contract, tort, or otherwise, for any indirect or consequential loss or damage, loss of use, loss of production, or loss of profits or interest costs, provided that this exclusion shall not apply to any obligation of the supplier to pay penalties and/or damages to the purchaser; and
- (b) The aggregate liability of the supplier to the purchaser, whether under the contract, in tort or otherwise, shall not exceed the total contract price, provided that this limitation shall not apply to the cost of repairing or replacing defective equipment.

29. Governing language

29.1 The contract shall be written in English. All correspondence and other documents pertaining to the contract that is exchanged by the parties shall also be written in English.

30. Applicable law

30.1 The contract shall be interpreted in accordance with South African laws, unless otherwise specified.

31. Notices

31.1 Every written acceptance of a bid shall be posted to the supplier concerned by registered or certified mail and any other notice to him shall be posted by ordinary mail to the address furnished in his bid or to the address notified later by him in writing and such posting shall be deemed to be proper service of such notice.

31.2 The time mentioned in the contract documents for performing any act after such aforesaid notice has been given, shall be reckoned from the date of posting of such notice.

Initial

32. Taxes and duties

32.1 A foreign supplier shall be entirely responsible for all taxes, stamp duties, license fees, and other such levies imposed outside the purchaser's country.

32.2 A local supplier shall be entirely responsible for all taxes, duties, license fees, etc., incurred until delivery of the contracted goods to the purchaser.

32.3 No contract shall be concluded with any bidder whose tax matters are not in order. Prior to the award of a bid SARS must have certified that the tax matters of the preferred bidder are in order.

32.4 No contract shall be concluded with any bidder whose municipal rates and taxes and municipal services charges are in arrears.

33. Transfer of contracts

33.1 The contractor shall not abandon, transfer, cede assign or sublet a contract or part thereof without the written permission of the purchaser

34. Amendment of contracts

34.1 No agreement to amend or vary a contract or order or the conditions, stipulations or provisions thereof shall be valid and of any force unless such agreement to amend or vary is entered into in writing and signed by the contracting parties. Any waiver of the requirement that the agreement to amend or vary shall be in writing, shall also be in writing.

35. Prohibition of restrictive practices

35.1 In terms of section 4 (1) (b) (iii) of the Competition Act No. 89 of 1998, as amended, an agreement between, or concerted practice by, firms, or a decision by an association of firms, is prohibited if it is between parties in a horizontal relationship and if a bidder(s) is / are or a contractor(s) was / were involved in collusive bidding.

35.2 If a bidder(s) or contractor(s) based on reasonable grounds or evidence obtained by the purchaser has / have engaged in the restrictive practice referred to above, the purchaser may refer the matter to the Competition Commission for investigation and possible imposition of administrative penalties as contemplated in section 59 of the Competition Act No 89 Of 1998.

35.3 If a bidder(s) or contractor(s) has / have been found guilty by the Competition Commission of the restrictive practice referred to above, the purchaser may, in addition and without prejudice to any other remedy provided for, invalidate the bid(s) for such item(s) offered, and / or terminate the contract in whole or part, and / or restrict the bidder(s) or contractor(s) from conducting business with the public sector for a period not exceeding ten (10) years and / or claim damages from the bidder(s) or contractor(s) concerned.

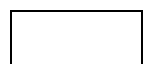

Initial

***NB:** This section to be completed by the Bidder

Signed at _____ On this _____ day of _____ 20____

As Witnesses: 1. _____ 2. _____

BIDDER (SUPPLIER) _____

***NB:** This section to be completed by the ODM

Signed at _____ On this _____ day of _____ 20____

As Witnesses: 1. _____ 2. _____

CLIENT (ODM) _____

Initial

APPLICATION OF PREFERENCE POINT SYSTEM IN TERMS OF THE PREFERENTIAL PROCUREMENT REGULATIONS 2022

The applicable **80/20** preferential points system as set out in Preferential Procurement Regulations 2022 will be used to evaluate individual quotations

Regulation 2721 of 4 November 2022 provides for a preference points system

80/20 Preference point system [(for acquisition of goods or services for a Rand value equal to or above R30 000 and up to R50 million) (all applicable taxes included)]

The points are awarded as follows:

- 80 points is awarded for the **lowest price** if it complies with the Bid / Formal Written Price Quotation conditions.
- 20 points are awarded for specific goals as shown in Table 1 and 2 on page 46 (MBD 6.1) paragraph 4

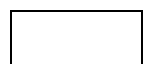

Initial

**SUPPLY AND INSTALL NEW 2200L DIESEL TANK AT DIE DAM HOLIDAY RESORT WITH
STAND AT DIE DAM HOLIDAY RESORT**

Q20-2023/24

<p>SCHEDULE: PREFERENCE POINTS CLAIM FORM IN TERMS OF THE PREFERENTIAL PROCUREMENT REGULATIONS 2022</p>
--

This preference form must form part of all Bids invited. It contains general information and serves as a claim form for preference points for specific goals.

NB: BEFORE COMPLETING THIS FORM, BIDDERS MUST STUDY THE GENERAL CONDITIONS, DEFINITIONS AND DIRECTIVES APPLICABLE IN RESPECT OF THE BID AND PREFERENTIAL PROCUREMENT REGULATIONS, 2022

1. GENERAL CONDITIONS

1.1 The following preference point systems are applicable to invitations to Bid:

- the 80/20 system for requirements with a Rand value of up to R50 000 000 (all applicable taxes included); and

1.2 To be completed by the organ of state

(Delete whichever is not applicable for this Bid).

a) The applicable preference point system for this Bid is the **80/20** preference point system.

1.3 Points for this Bid (even in the case of a Bid for income-generating contracts) shall be awarded for:

- (a) Price; and
- (b) Specific Goals.

1.4 To be completed by the organ of state:

The maximum points for this Bid are allocated as follows:

	POINTS
PRICE	80
SPECIFIC GOALS	20
Total points for Price and SPECIFIC GOALS	100

1.5 Failure on the part of a Bidder to submit proof or documentation required in terms of this Bid to claim points for specific goals with the Bid, will be interpreted to mean that preference points for specific goals are not claimed.

1.6 The organ of state reserves the right to require of a Bidder, either before a Bid is adjudicated or at any time subsequently, to substantiate any claim in regard to preferences, in any manner required by the organ of state.

--

Initial

2. DEFINITIONS

- (a) **“Bid”** means a written offer in the form determined by an organ of state in response to an invitation to provide goods or services through price quotations, competitive Bidding process or any other method envisaged in legislation;
- (b) **“price”** means an amount of money Tendered for goods or services, and includes all applicable taxes less all unconditional discounts;
- (c) **“rand value”** means the total estimated value of a contract in Rand, calculated at the time of bid invitation, and includes all applicable taxes;
- (d) **“Bid for income-generating contracts”** means a written offer in the form determined by an organ of state in response to an invitation for the origination of income-generating contracts through any method envisaged in legislation that will result in a legal agreement between the organ of state and a third party that produces revenue for the organ of state, and includes, but is not limited to, leasing and disposal of assets and concession contracts, excluding direct sales and disposal of assets through public auctions; and
- (e) **“the Act”** means the Preferential Procurement Policy Framework Act, 2000 (Act No. 5 of 2000).

3. FORMULAE FOR PROCUREMENT OF GOODS AND SERVICES

3.1 POINTS AWARDED FOR PRICE

3.1.1 THE 80/20 OR 90/10 PREFERENCE POINT SYSTEMS

A maximum of 80 or 90 points is allocated for price on the following basis:

80/20

$$Ps = 80 \left(1 - \frac{Pt - P_{min}}{P_{min}} \right)$$

Where

- Ps = Points scored for price of Bid under consideration
- Pt = Price of Bid under consideration
- Pmin = Price of lowest acceptable Bid

3.2 FORMULAE FOR DISPOSAL OR LEASING OF STATE ASSETS AND INCOME GENERATING PROCUREMENT

3.2.1 POINTS AWARDED FOR PRICE

A maximum of 80 or 90 points is allocated for price on the following basis:

80/20

$$Ps = 80 \left(1 + \frac{Pt - P_{max}}{P_{max}} \right)$$

Where

- Ps = Points scored for price of Bid under consideration
- Pt = Price of Bid under consideration
- Pmax = Price of highest acceptable Bid



Initial

4. POINTS AWARDED FOR SPECIFIC GOALS

- 4.1. In terms of Regulation 4(2); 5(2); 6(2) and 7(2) of the Preferential Procurement Regulations, preference points must be awarded for specific goals stated in the Bid. For the purposes of this Bid the Bidder will be allocated points based on the goals stated in table 1 below as may be supported by proof/ documentation stated in the conditions of this Bid:
- 4.2. In cases where organs of state intend to use Regulation 3(2) of the Regulations, which states that, if it is unclear whether the 80/20 or 90/10 preference point system applies, an organ of state must, in the Bid documents, stipulate in the case of—
- a) an invitation for Bid for income-generating contracts, that either the 80/20 or 90/10 preference point system will apply and that the highest acceptable Bid will be used to determine the applicable preference point system; or
 - b) any other invitation for Bid, that either the 80/20 or 90/10 preference point system will apply and that the lowest acceptable Bid will be used to determine the applicable preference point system,

then the organ of state must indicate the points allocated for specific goals for both the 90/10 and 80/20 preference point system.

SPECIFIC GOALS FOR THE BID AND POINTS CLAIMED ARE INDICATED PER THE TABLE BELOW.

Table 1: Number of points for contracting with persons, or categories of persons, historically disadvantaged by unfair discrimination on the basis of race, gender or disability.

50% of the 20/10 points must be allocated to promote this goal and points will be allocated in terms of the BBBEE scorecard as follows eg. Level 1 = 20 points therefore 50% of 20 = 10 points

B-BBEE Status Level of Contributor	Number of Points for Preference (80/20)
1	20
2	18
3	16
4	12
5	8
6	6
7	4
8	2
Non-compliant contributor	0

Table 2: Number of Points for Promotion of Enterprises located in the District and Province

50% of the 20/10 points must be allocated to promote this goal and points will be allocated as follows:

Locality of supplier (The bidders documents of incorporation (CIPC / CIPRO) will be used to verify the locality – Address of registered office)	Number of Points for 80/20 Preference Points System
Within the boundaries of Overberg District	6
Within the boundaries of the Western Cape	4
Outside of the boundaries of the Western Cape	0

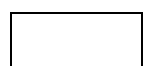

Initial

Points claimed and Points awarded

Note to Bidders: The Bidder must indicate how they claim points for each preference point system.)

The specific goals allocated points in terms of this Bid	Number of points allocated (80/20 system) (To be completed by the organ of state)	Number of points claimed (80/20 system) (To be completed by the Bidder)
Area of supplier (Bidders can only score the following points: 80/20 6, 4 or 0 points)		
Within the boundaries of Overberg District		
Within the boundaries of the Western Cape		
Outside of the boundaries of the Western Cape		
B-BBEE Status Level of Contributor		
1		
2		
3		
4		
5		
6		
7		
8		
Non-compliant contributor		

Initial

DECLARATION WITH REGARD TO COMPANY/FIRM

4.3 Name of company/firm.....

4.4 Company registration number:

4.5 TYPE OF COMPANY/ FIRM

- Partnership/Joint Venture / Consortium
 - One-person business/sole propriety
 - Close corporation
 - Public Company
 - Personal Liability Company
 - (Pty) Limited
 - Non-Profit Company
 - State Owned Company
- [TICK APPLICABLE BOX]

4.6 I, the undersigned, who is duly authorised to do so on behalf of the company/firm, certify

that the points claimed, based on the specific goals as advised in the Bid, qualifies the company/ firm for the preference(s) shown and I acknowledge that:

- i) The information furnished is true and correct;
- ii) The preference points claimed are in accordance with the General Conditions as indicated in paragraph 1 of this form;
- iii) In the event of a contract being awarded as a result of points claimed as shown in paragraphs 1.4 and 4.2, the contractor may be required to furnish documentary proof to the satisfaction of the organ of state that the claims are correct;
- iv) If the specific goals have been claimed or obtained on a fraudulent basis or any of the conditions of contract have not been fulfilled, the organ of state may, in addition to any other remedy it may have –
 - (a) disqualify the person from the Biding process;
 - (b) recover costs, losses or damages it has incurred or suffered as a result of that person’s conduct;
 - (c) cancel the contract and claim any damages which it has suffered as a result of having to make less favourable arrangements due to such cancellation;
 - (d) recommend that the Bidder or contractor, its shareholders and directors, or only the shareholders and directors who acted on a fraudulent basis, be restricted from obtaining business from any organ of state for a period not exceeding 10 years, after the *audi alteram partem* (hear the other side) rule has been applied; and
 - (e) forward the matter for criminal prosecution, if deemed necessary.

Figure 1

<p>WITNESSES</p> <p>1.</p> <p>2.</p>
--

<p>.....</p> <p>SIGNATURE(S) OF BIDDERS(S)</p>
<p>DATE:</p> <p>ADDRESS</p> <p>.....</p> <p>.....</p>

BROAD-BASED BLACK ECONOMIC EMPOWERMENT (B-BBEE) STATUS LEVEL CERTIFICATES

A bidder who qualifies as an EME in terms of the B-BBEE Act **must** submit a sworn affidavit confirming Annual Total Revenue and Level of Black Ownership.

A Bidder other than EME or QSE **must submit their original and valid B-BBEE status level verification certificate or a certified copy** thereof, substantiating their B-BBEE rating issued by a Registered Auditor approved by IRBA or a Verification Agency accredited by SANAS.

MINIMUM REQUIREMENTS FOR VALID B-BBEE STATUS LEVEL VERIFICATION CERTIFICATES (The following information must be on the face of the certificate)	Indicate with (x)	
	yes	no
The name and the physical location of the measured entity		
The registration number and, where applicable, the VAT number of the measured entity		
The date of issue and date of expiry		
The certificate number for identification and reference		
The scorecard that was used (for example EME, QSE or Generic)		
The name and / or logo of the verification Agency		
The SANAS logo		
The certificate must be signed by the authorized person from the Verification Agency		
The B-BBEE Status level of Contribution obtained by the measured entity.		

Failure on the part of a bidder to claim, fill in and/or to sign MBD 6.1 and submit a B-BBEE Verification Certificate from a Verification Agency accredited by the South African Accreditation System (SANAS), or a Registered Auditor approved by the Independent Regulatory Board of Auditors (IRBA) or a sworn affidavit confirming annual turnover and level of black ownership in case of an EME and QSE together with the bid, will be interpreted to mean that preference points for B-BBEE status level of contribution are not claimed.

Signed Date

Name Position

Bidder

Initial

FOR INFORMATION PURPOSES ONLY

PLEASE NOTE THE FOLLOWING REQUIREMENTS REGARDING VALIDATION OF B-BBEE SCORE.

1. EMEs

ONLY THE FOLLOWING WILL BE ACCEPTED:

- 1.1. **A VALID ORIGINAL** sworn affidavit, confirming annual turnover and level of black ownership or
- 1.2. **A VALID** affidavit / certificate issued by Companies Intellectual Property Commission (CIPC); or
- 1.3. **A VALID ORIGINAL** B-BBEE status level verification certificate or **A CERTIFIED COPY** thereof, substantiating their B-BBEE rating issued by:
 - 1.3.1. A registered Auditor approved by the Independent Regulatory Board for Auditors (IRBA); **or**
 - 1.3.2. A verification Agency accredited by the South African National Accreditation System (SANAS).

2. QSEs

ONLY THE FOLLOWING WILL BE ACCEPTED:

- 2.1. **A VALID ORIGINAL** sworn affidavit, confirming annual turnover and level of black ownership or
- 2.2. **A VALID ORIGINAL** B-BBEE status level verification certificate or **A CERTIFIED COPY** thereof, substantiating their B-BBEE rating issued by:
 - 2.2.1. A registered Auditor approved by IRBA; or
 - 2.2.2. A verification Agency accredited by SANAS.

3. BIDDERS OTHER THAN EMEs & QSE's

- 3.1. The bidder **MUST** submit either a **VALID ORIGINAL B-BBEE** status level verification certificate or **A CERTIFIED COPY** thereof, substantiating their **B-BBEE** rating issued by:
 - 3.1.1. A Registered Auditor approved by IRBA; or
 - 3.1.2. A Verification Agency accredited by SANAS.

2. WHEN CONFIRMING THE VALIDITY OF CERTIFICATES ISSUED BY AN AUDITOR REGISTERED WITH IRBA, THE FOLLOWING SHOULD BE DETAILED ON THE FACE OF THE CERTIFICATE:

- 4.1. The Auditor's letterhead with FULL contact details;
- 4.2. The Auditor's practice number;
- 4.3. The name and physical location of the measured entity;
- 4.4. The registration number and, where applicable, the VAT number of the measured entity;
- 4.5. The date of issue and date of expiry;
- 4.6. The B-BBEE Status Level of Contribution obtained by the measured entity; and
- 4.7. The total black shareholding and total black female shareholding.

Initial

MBD 6.1(a)**SWORN AFFIDAVIT – B-BBEE EXEMPTED MICRO ENTERPRISE**

I, the undersigned,

Full name & Surname	
Identity number	

Hereby declare under oath as follows:

1. The contents of this statement are to the best of my knowledge a true reflection of the facts.
2. I am a member / director / owner of the following enterprise and am duly authorised to act on its behalf:

Enterprise Name	
Trading Name	
Registration Number	
Enterprise Address	

3. I hereby declare under oath that:

The enterprise is _____% black owned;

The enterprise is _____% black woman owned;

Based on the management accounts and other information available on the _____ financial year, the income did not exceed R10, 000,000.00 (ten million rands);

Please confirm on the table below the B-BBEE level contributor, by ticking the applicable box.

100% black owned	Level One (135% B-BBEE procurement recognition)	
More than 51% black owned	Level Two (125% B-BBEE procurement recognition)	
Less than 51% black owned	Level Four (100% B-BBEE procurement recognition)	

4. The entity is an empowering supplier in terms of **the dti** Codes of Good Practice.
5. I know and understand the contents of this affidavit and I have no objection to take the prescribed oath and consider the oath binding on my conscience and on the owners of the enterprise which I represent in this matter.
6. The sworn affidavit will be valid for a period of 12 months from the date signed by commissioner.

Deponent Signature: _____

Date: _____

Commissioner of Oaths name,
Signature, Stamp & Date

Initial

--

CONTRACT FORM – PURCHASE OF GOODS/WORKS

THIS FORM MUST BE FILLED IN DUPLICATE BY BOTH THE SUCCESSFUL BIDDER (PART 1) AND THE PURCHASER (PART 2). BOTH FORMS MUST BE SIGNED IN THE ORIGINAL SO THAT THE SUCCESSFUL BIDDER AND THE PURCHASER WOULD BE IN POSSESSION OF ORIGINALLY SIGNED CONTRACTS FOR THEIR RESPECTIVE RECORDS.

PART 1 (TO BE FILLED IN BY THE BIDDER)

1. I hereby undertake to supply all or any of the goods and/or works described in the attached bidding documents to **Overberg District Municipality** in accordance with the requirements and specifications stipulated in bid number **Q20-2023/24** at the price/s quoted. My offer/s remains binding upon me and open for acceptance by the purchaser during the validity period indicated and calculated from the closing time of bid.
2. The following documents shall be deemed to form and be read and construed as part of this agreement:
 - (i) Bidding documents, viz
 - Invitation to bid;
 - Tax clearance certificate or Tax clearance certificate PIN;
 - Pricing schedule(s);
 - Technical Specification(s);
 - Preference claims for Broad Based Black Economic Empowerment Status Level of Contribution in terms of the Preferential Procurement Regulations 2022;
 - Declaration of interest;
 - Declaration of bidder's past SCM practices;
 - Certificate of Independent Bid Determination
 - Special Conditions of Contract;
 - (ii) General Conditions of Contract; and
 - (iii) Other (specify)
3. I confirm that I have satisfied myself as to the correctness and validity of my bid; that the price(s) and rate(s) quoted cover all the goods and/or works specified in the bidding documents; that the price(s) and rate(s) cover all my obligations and I accept that any mistakes regarding price(s) and rate(s) and calculations will be at my own risk.
4. I accept full responsibility for the proper execution and fulfilment of all obligations and conditions devolving on me under this agreement as the principal liable for the due fulfilment of this contract.
5. I declare that I have no participation in any collusive practices with any bidder or any other person regarding this or any other bid.
6. I confirm that I am duly authorised to sign this contract.

NAME (PRINT)

CAPACITY

SIGNATURE

NAME OF FIRM

DATE

WITNESSES	
1
2.

Initial

***NB:** This form to be completed by the ODM

CONTRACT FORM – PURCHASE OF GOODS/WORKS

PART 2 (TO BE FILLED IN BY THE PURCHASER)

I..... in my capacity
as

- I. Accept your bid under reference number **Q20-2023/24** dated
- for the supply of goods/works indicated hereunder and/or further specified in the annexure(s).
- II. An official order indicating delivery instructions is forthcoming.
- III. I undertake to make payment for the goods/works delivered in accordance with the terms and conditions of the contract, within 30 (thirty) days after receipt of an invoice accompanied by the delivery note.

ITEM NO.	PRICE (ALL APPLICABLE TAXES INCLUDED)	BRAND	DELIVERY PERIOD	B-BBEE STATUS LEVEL OF CONTRIBUTION	MINIMUM THRESHOLD FOR LOCAL PRODUCTION AND CONTENT (if applicable)

a. I confirm that I am duly authorized to sign this contract.

SIGNED ATON.....

NAME (PRINT)

SIGNATURE

OFFICIAL STAMP

WITNESSES

1.

2.

Initial

DECLARATION OF BIDDER'S PAST SUPPLY CHAIN MANAGEMENT PRACTICES

1. This Standard Bidding Document must form part of all bids invited.
2. It serves as a declaration to be used by institutions in ensuring that when goods and services are being procured, all reasonable steps are taken to combat the abuse of the supply chain management system.
3. The bid of any bidder may be disregarded if that bidder or any of its directors have-
 - a. abused the institution's supply chain management system.
 - b. committed fraud or any other improper conduct in relation to such system; or
 - c. failed to perform on any previous contract.
4. **In order to give effect to the above, the following questionnaire must be completed and submitted with the bid.**

4.1	Is the bidder or any of its directors listed on the National Treasury's database as a company or person prohibited from doing business with the public sector? (Companies or persons who are listed on this database were informed in writing of this restriction by the National Treasury after the <i>audi alteram partem</i> rule was applied).	Yes	No
4.1.1	If so, furnish particulars:		
4.2	Is the bidder or any of its directors listed on the Register for Bid Defaulters in terms of section 29 of the Prevention and Combating of Corrupt Activities Act (No 12 of 2004)? (To access this Register enter the National Treasury's website, www.treasury.gov.za, click on the icon "Register for Bid Defaulters" or submit your written request for a hard copy of the Register to facsimile number (012) 3265445.)	Yes	No
4.2.1	If so, furnish particulars:		
4.3	Was the bidder or any of its directors convicted by a court of law (including a court outside of the Republic of South Africa) for fraud or corruption during the past five years?	Yes	No
4.3.1	If so, furnish particulars:		
4.4	Was any contract between the bidder and the municipality / municipal entity or any other organ of state terminated during the past five years on account of failure to perform on or comply with the contract?	Yes	No
4.4.1	If so, furnish particulars:		
4.5	Does the bidder or any of its directors owe any municipal rates and taxes or municipal charges to the municipality / municipal entity, or to any other municipality / municipal entity, that is in arrears for more than three months?	Yes	No
4.5.1	If so, furnish particulars:		

Initial

CERTIFICATION

I, THE UNDERSIGNED (FULL NAME)

CERTIFY THAT THE INFORMATION FURNISHED ON THIS DECLARATION FORM TRUE AND CORRECT.

I ACCEPT THAT, IN ADDITION TO CANCELLATION OF A CONTRACT, ACTION MAY BE TAKEN AGAINST ME SHOULD THIS DECLARATION PROVE TO BE FALSE.

.....

Signature

.....

Date

.....

Position

.....

Name of Bidder

Initial

NOTIFICATION OF DECISION

1. If the Municipal Manager or the Chief Financial Officer, has resolved that a quotation be accepted, the successful and unsuccessful bidders shall be notified in writing of this decision.
2. Bidders are also hereby informed of their right to request reasons for the decision in terms of the Promotion of Administrative Justice Act (No 3 of 2000).
3. The notification of decision sent to the successful bidder is not acceptance in terms of the form of offer and acceptance and no rights shall accrue to the successful bidder in terms of this notification.

Initial

CERTIFICATE OF INDEPENDENT BID DETERMINATION

1. This Municipal Bidding Document (MBD) must form part of all bids¹ invited.
2. Section 4 (1) (b) (iii) of the Competition Act No. 89 of 1998, as amended, prohibits an agreement between, or concerted practice by, firms, or a decision by an association of firms, if it is between parties in a horizontal relationship and if it involves collusive bidding (or bid rigging)². Collusive bidding is a *pe se* prohibition meaning that it cannot be justified under any grounds.
3. Municipal Supply Regulation 38 (1) prescribes that a supply chain management policy must provide measures for the combating of abuse of the supply chain management system, and must enable the accounting officer, among others, to:
 - (a) take all reasonable steps to prevent such abuse;
 - (b) reject the bid of any bidder if that bidder or any of its directors has abused the supply chain management system of the municipality or municipal entity or has committed any improper conduct in relation to such system; and
 - (c) cancel a contract awarded to a person if the person committed any corrupt or fraudulent act during the bidding process or the execution of the contract.
4. This MBD serves as a certificate of declaration that would be used by institutions to ensure that, when bids are considered, reasonable steps are taken to prevent any form of bid-rigging.
5. In order to give effect to the above, the attached Certificate of Bid Determination (MBD 9) must be completed and submitted with the bid:

¹ Includes price quotations, advertised competitive bids, limited bids and proposals.

² Bid rigging (or collusive bidding) occurs when businesses, that would otherwise be expected to compete, secretly conspire to raise prices or lower the quality of goods and / or services for purchasers who wish to acquire goods and / or services through a bidding process. Bid rigging is, therefore, an agreement between competitors not to compete.

Initial

CERTIFICATE OF INDEPENDENT BID DETERMINATION

I, the undersigned, in submitting the accompanying bid:

BID NO: Q20-2023/24

SUPPLY AND INSTALL NEW 2200L DIESEL TANK AT DIE DAM HOLIDAY RESORT WITH STAND AT DIE DAM HOLIDAY RESORT

In response to the invitation for the bid made by:

OVERBERG DISTRICT MUNICIPALITY

Do hereby make the following statements that I certify to be true and complete in every respect:

I certify, on behalf of: _____ that:
(Name of Bidder)

- i. I have read, and I understand the contents of this Certificate;
- ii. I understand that the accompanying bid will be disqualified if this Certificate is found not to be true and complete in every respect;
- iii. I am authorized by the bidder to sign this Certificate, and to submit the accompanying bid, on behalf of the bidder;
- iv. Each person whose signature appears on the accompanying bid has been authorized by the bidder to determine the terms of, and to sign, the bid, on behalf of the bidder;
- v. For the purposes of this Certificate and the accompanying bid, I understand that the word "competitor" shall include any individual or organization, other than the bidder, whether or not affiliated with the bidder, who:
 - (a) Has been requested to submit a bid in response to this bid invitation;
 - (b) Could potentially submit a bid in response to this bid invitation, based on their qualifications, abilities or experience; and
 - (c) Provides the same goods and services as the bidder and/or is in the same line of business as the bidder, who:
- vi. The bidder has arrived at the accompanying bid independently from, and without consultation, communication, agreement or arrangement with any competitor. However, communication between partners in a joint venture or consortium³ will not be construed as collusive bidding.

³ Joint venture or Consortium means an association of persons for the purpose of combining their expertise, property, capital, efforts, skill and knowledge in an activity for the execution of a contract.

Initial

- vii. In particular, without limiting the generality of paragraphs 6 above, there has been no consultation, communication, agreement or arrangement with any competitor regarding:
 - (a) Prices;
 - (b) Geographical area where product or service will be rendered (market allocation)
 - (c) Methods, factors or formulas used to calculate prices;
 - (d) The intention or decision to submit or not to submit, a bid;
 - (e) The submission of a bid which does not meet the specifications and conditions of the bid; or
 - (f) Bidding with the intention not to win the bid.

- viii. In addition, there have been no consultations, communications, agreements, or arrangements with any competitor regarding the quality, quantity, specifications and conditions or delivery particulars of the products or services to which this bid invitation relates.

- ix. The terms of the accompanying bid have not been, and will not be, disclosed by the bidder, directly or indirectly, to any competitor, prior to the date and time of the official bid opening or of the awarding of the contract.

- x. I am aware that, in addition and without prejudice to any other remedy provided to combat any restrictive practices related to bids and contracts, bids that are suspicious will be reported to the Competition Commission for investigation and possible imposition of administrative penalties in terms of section 59 of the Competition Act No. 89 of 1998 and or may be reported to the National Prosecuting Authority (NPA) for criminal investigation and or may be restricted from conducting business with the public sector for a period not exceeding ten (10) years in terms of the Prevention and Combating of Corrupt Activities Act No. 12 of 2004 or any other applicable legislation.

SIGNATURE		NAME (PRINT)	
CAPCITY		DATE	
NAME OF FIRM			

Initial

KEY PERFORMANCE INDICATORS

No	Key Performance Indicators (KPIs)
1	Project management and control
2	Communications
3	Flexibility
4	Capability
5	Delivery

I / We acknowledge that I / we am / are fully acquainted with the abovementioned Key Performance Indicators (KPIs) applicable to this Bid / contract as stipulated by the Municipality and that I / we accept these Key Performance Indicators (KPIs) in all respects.

I / We furthermore confirm I / we satisfied myself / ourselves as to the corrections and validity of my / our Bid: that the price quoted cover all the work / item(s) specified in the Bid document and that the price cover all my / our obligations under a resulting contract and that I / we accept that any mistake(s) regarding price and calculations will be at my / our risk.

SIGNATURE		NAME (PRINT)	
CAPCITY		DATE	
NAME OF FIRM			
WITNESS 1		WITNESS 2	

Initial

--

**IMPORTANT DOCUMENTATION
AND INFORMATION**

NB: Any bidder who fails to complete, attach, and sign the following documents will automatically be disqualified.

- 1) **Valid Tax Clearance Certificate or Tax Compliance Status PIN.**
- 2) The following documents must be completed and signed:
 - MBD 3.1 Pricing Schedule-Firm Prices.
 - MBD 4 Declaration of Interest
 - MBD 5 General Conditions of Contract
 - MBD 6.1 Schedule: Preference Points Claim Form in Terms of the Preferential Procurement Regulations 2022
 - MBD 7.1 Contract Form – Purchase of Goods/Works (Part 1)
 - MBD 8 Declaration of Bidders past Supply Chain Management Practices
 - MBD 9 Certificate of Independent Bid Determination
 - FORM OF OFFER
- 3) Annexure:
 - A – Authorization to deduct outstanding amounts owed to Council
 - B – Certificate for municipal services and payments to service providers
 - **Municipal Accounts of the Company AND of each Director/Member/Partner must be attached.**
- 4) Bid documents must be completed in black ink (written or typed). **We do not accept any electronic signatures.** In the event of a mistake having been made on the Bid documents, it must be crossed out in ink and be accompanied by a full signature at each alteration. **No correction fluid may be used in this Bid document. Please do not re-type the document.**
- 5) Form of Offer and Acceptance – **COMPULSORY TO COMPLETE!**

Initial



BID NO: Q20-2023/24:

SUPPLY AND INSTALL NEW 2200L DIESEL TANK AT DIE DAM HOLIDAY RESORT WITH STAND AT DIE DAM HOLIDAY RESORT

Authorization to deduct outstanding amounts.

To: Municipal Manager, Overberg District Municipality

From: _____
(Name of Bidder or Consortium)

AUTHORISATION FOR THE DEDUCTION OF OUTSTANDING AMOUNTS OWED TO COUNCIL

I, THE UNDERSIGNED, _____,
(Full name in block letters)

Hereby authorize the Overberg District Municipality to deduct the full amount outstanding by the business organization / Director, shareholder, partner, etc. from any payment due to us / me.

Signature

THUS, DONE AND SIGNED for and on behalf of the Bidder / Contractor

At _____ On the _____ Day of _____ 20____
(Place) (Day) (Month) (Year)

In the presence of the subscribing witnesses.

AS WITNESSES:

1 _____ Name in Block Letters: _____
(Signature)

2 _____ Name in Block Letters: _____
(Signature)

Initial

PAYMENT OF MUNICIPAL ACCOUNTS

In terms of the Municipal Supply Chain Management Policy and System and its Preferential Procurement Policy, Bidders **must** ensure that they are up-to date with their payments of municipal accounts.

The Bidder **must attach to this page**, a Latest Municipal account, which provides proof that his payment of Municipal accounts is up-to-date and complete the certificate for municipal services on the next page. In the event of leasing, a lease agreement **Must** be attached to the Bid document.

Signed

Date

Name

Position

Bidder

Initial

CERTIFICATE FOR MUNICIPAL SERVICES (COMPULSORY TO COMPLETE)
DECLARATION IN TERMS OF CLAUSE 112(1) OF THE MUNICIPAL FINANCE MANAGEMENT ACT (NO.56 OF 2003)
 - (To be signed in the presence of a Commissioner of Oaths)

I, _____, _____ (full name and ID no.), hereby acknowledge that according to SCM Regulation 38(1)(d)(i), the Municipality may reject the Bid of the Bidder if any municipal rates and taxes or municipal service charges owed by the Bidder or any of its directors/members/partners to the Overberg District Municipality, or to any other municipality or municipal entity, are in arrears for more than 3 (three) months.

I declare that I am duly authorised to act on behalf of _____ (name of the firm) and hereby declare, that to the best of my personal knowledge, neither the firm nor any director/member/partner of said firm is in arrears on any of its municipal accounts with any municipality in the Republic of South Africa, for a period longer than 3 (three) months.

I further hereby certify that the information set out in this schedule and/or attachment(s) hereto is true and correct. The Bidder acknowledges that failure to complete this schedule properly and truthfully may result in the Bid being disqualified, and/or in the event that the Bidder is successful, the cancellation of the contract.

PHYSICAL BUSINESS ADDRESS(ES) OF THE BIDDER	MUNICIPAL ACCOUNT NUMBER

FURTHER DETAILS OF THE BIDDER'S Director / Shareholder Partners, ect.:

Director /Shareholder / partner	Physical address of the Business	Municipal Account number(s)	Physical residential address of the Director / shareholder / partner	Municipal Account number(s)

NB: Please attach certified copy(ies) of ID document(s)
 If the entity or any of its Directors/Shareholders/Partners, etc. rents/leases premises, a copy of the rental/lease agreement must be submitted with this Bid.

Number of sheets appended by the Bidder to this schedule (If nil, enter NIL)

Signature	Position	Date

COMMISSIONER OF OATHS	Apply official stamp of authority on this page:
Signed and sworn to before me at _____, on this _____ day of _____ 20____ by the Deponent, who has acknowledged that he/she knows and understands the contents of this Affidavit, it is true and correct to the best of his/her knowledge and that he/she has no objection to taking the prescribed oath, and that the prescribed oath will be binding on his/her conscience. COMMISSIONER OF OATHS:- Position and name: _____ Signature: _____ Address _____ _____ Tel: _____	

Initial

--



COMPULSORY TO COMPLETE

CHECK LIST FOR COMPLETENESS OF BID DOCUMENT

The bidder must ensure that the following checklist is completed, that the necessary documentation is attached to this bid document and that all declarations are signed:

**Mark with "X" where applicable*

Items to be checked	Yes	No	Comments
1. Completed page containing the details of bidder			
2. Valid tax clearance certificate attached to bid document (MBD 2). a. Bidders who are registered on the municipality's accredited supplier database and attached a valid tax clearance certificate or TCC PIN to their database application form does not need to submit a tax clearance certificate with their bid document.			
3. Adhered to the pricing instructions (MBD 3.1)			
4. Schedule of previous experience of bidder on page 5 must be completed			
5. Completed and signed declaration of interest (MBD 4)			
6. Signed General Conditions of contract (MBD 5)			
7. Completed and signed Local Content Declaration (MBD6.2)			
8. Complete and signed contract form – purchases of goods / works (MBD7.1)			
9. Signed declaration of bidder's past supply chain management practices (MBD 8)			
10. Certificate of independent bid determination (MBD 9) be completed and signed			
11. Attached municipal account (s) of the business AND of each director/member/partner of the business.			
12. Bidder must initial every page of this bid document			

CERTIFICATION

I, THE UNDERSIGNED (FULL NAME) _____

CERTIFY THAT THE INFORMATION FURNISHED ON THIS CHECKLIST IS TRUE AND CORRECT.

Signature

Date

Position

Name

Initial

--

ANNEXURE AA

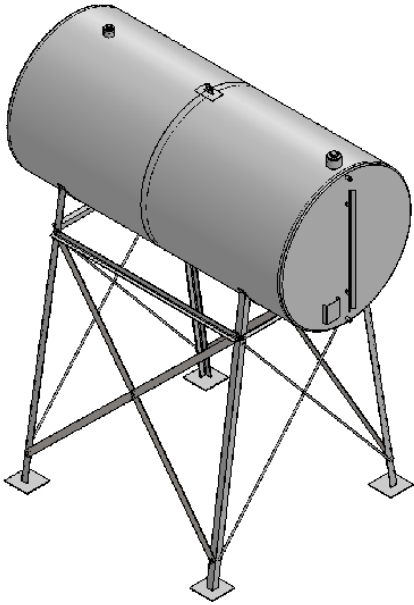

ANNEXURE AA -
SPECS - 2200LT BTF T

	Design Data	
	Design Standard	SANS 10131:2004
Shell Material	2mm Commercial Quality	
Flanges	ANSI B 16.5 150ASA Mild Steel	
Piping	SANS 62-1 & SANS 62-2	
Leak Test	20 kPa Internal Pneumatic Pressure	
External Surface Preparation	Sandblast SA 2.5	
External Coating	Paint - Forgeweld Gray	
External Surface Coating Test	DFT @ 75µm	
Gaskets	3mm Non-asbestos Fibre Ring	
Tank Volume (Calculated)	±2.50 m ³	
Tank Weight (Calculated)	±280 kg	
Overall Length (Calculated)	±2420 mm	

<p style="font-size: small; margin: 0;">PROPRIETARY AND CONFIDENTIAL THE INFORMATION CONTAINED IN THIS DRAWING IS THE SOLE PROPERTY OF FORGEWELD (PTY) LTD. ANY REPRODUCTION IN PART OR AS A WHOLE WITHOUT THE WRITTEN PERMISSION OF FORGEWELD (PTY) LTD IS PROHIBITED.</p>	DO NOT SCALE DRAWING	REVISION	01	<p style="font-size: x-small; margin: 0;">LEADERS IN STEEL TANK MANUFACTURE, SINCE 1963.</p>	
	DRAWN	NAME	SIGNATURE		DATE
	CHD	P Pienaar	PHP		4/25/2016
	APPV	J Mataboge	JM		4/25/2016
TITLE			DWG NO.	A3	
3D View			BFTANK115-rev1	SHEET 1 OF 7	

Initial

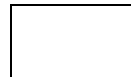

ITEM NO.	PART NUMBER	DESCRIPTION	QTY.
1	BRPLAT260	Plate 3650 x 1225 x 2mm	2
2	BRPLAT050	Plate 1200 x 1200 x 2mm	2
3	BRBASE000	Base Plate 160 x 100 x 2mm	1
4	BRLIFT010	Lifting Lug BTF - 6mm	1
5	BSIGH001	Sight Glass Bracket - BTF	1
6	BRSOCK120	80NB Steam Socket Wrought Steel	1
7	BRSOCK100	50NB Steam Socket Wrought Steel	1
8	BRSOCK060	25NB Steam Socket Wrought Steel	1
9	BRSOCK045	15NB Steam Socket Wrought Steel	3
10	BRBOLT065	M12 x 30 Bolt	10
11	BRBOLT050	M12 Nut	10
12	BSSTAN005	Stand 2 Metre	1
13	BRNAME015	Name Plate Bracket	1

DO NOT SCALE DRAWING		REVISION 01	
NAME	DESIGNED BY	DATE	
DESIGN	P Pienaar	PHP	4/25/2016
CHECKED	J Mataboge	JM	4/25/2016
APPV			
REV			

PROPRIETARY AND CONFIDENTIAL
THE INFORMATION CONTAINED IN THIS
DRAWING IS THE SOLE PROPERTY OF
FORGEWELD (PTY) LTD. ANY
REPRODUCTION IN PART OR AS A WHOLE
WITHOUT THE WRITTEN PERMISSION OF
FORGEWELD (PTY) LTD IS PROHIBITED.

LEADERS IN STEEL TANK MANUFACTURE, SINCE 1953.

DWG NO. BFTANK115-rev1 A3

General Arrangement Drawing

Initial

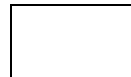

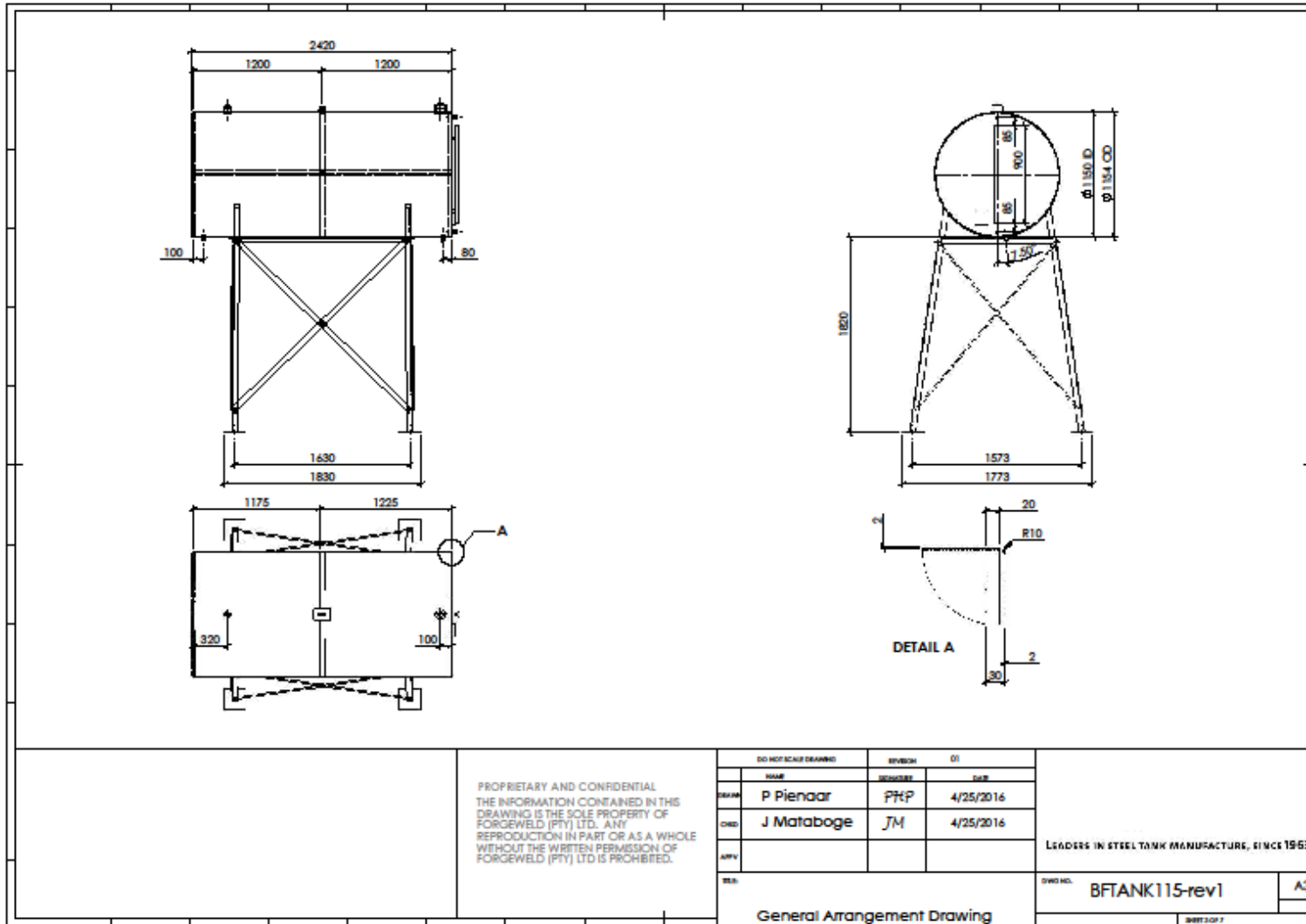

PROPRIETARY AND CONFIDENTIAL
 THE INFORMATION CONTAINED IN THIS
 DRAWING IS THE SOLE PROPERTY OF
 FORGEWELD (PTY) LTD. ANY
 REPRODUCTION IN PART OR AS A WHOLE
 WITHOUT THE WRITTEN PERMISSION OF
 FORGEWELD (PTY) LTD IS PROHIBITED.

DO NOT SCALE DRAWING		REVISION	DATE
NO.	NAME	ISSUED BY	DATE
001	P Pienaar	PKP	4/25/2016
002	J Mataboge	JM	4/25/2016
003			
004			

LEADERS IN STEEL TANK MANUFACTURE, SINCE 1953.

General Arrangement Drawing		DWG NO. BFTANK115-rev1	A3
		SHEET 1 OF 7	

Initial

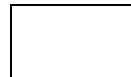

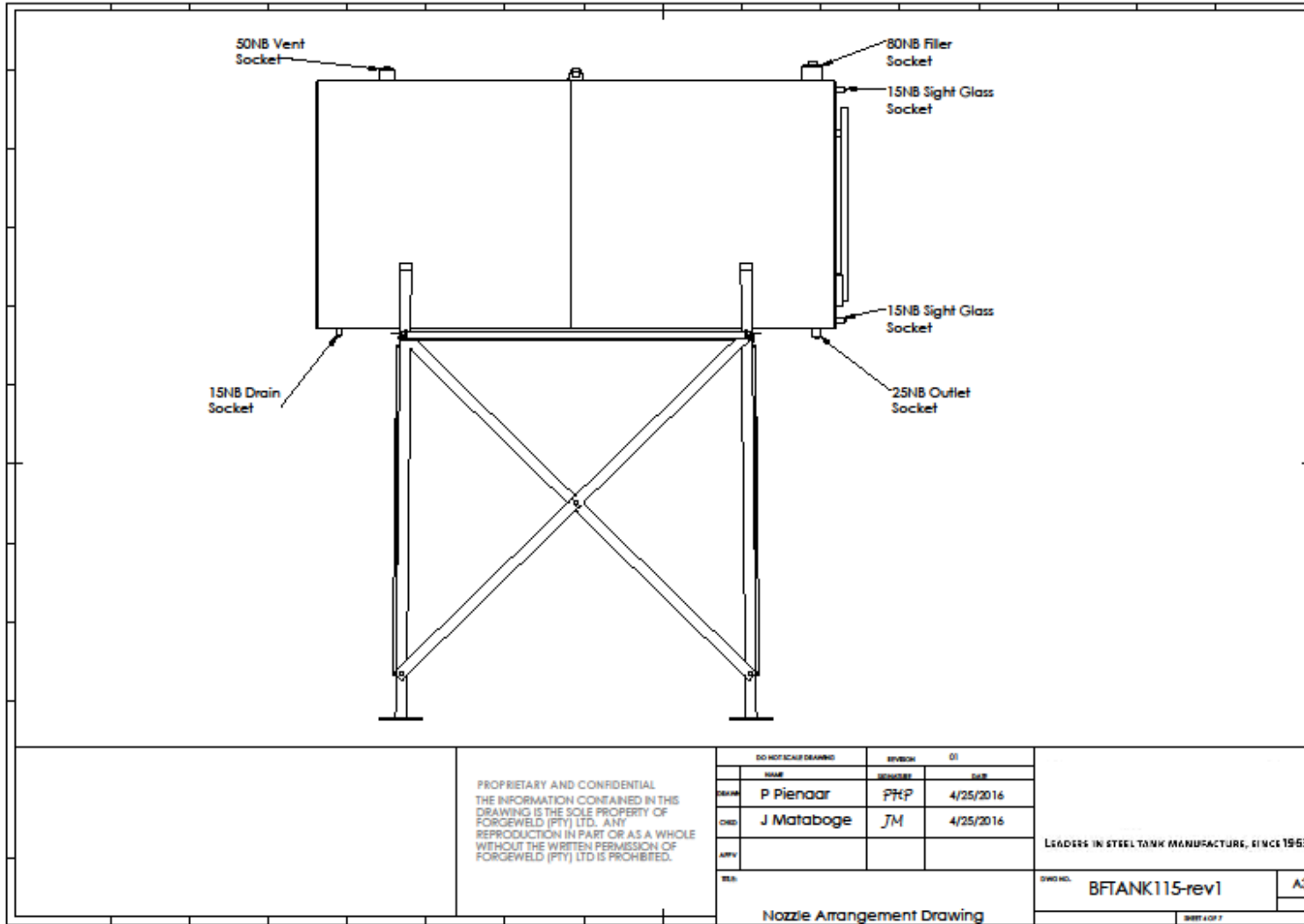

Initial

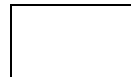

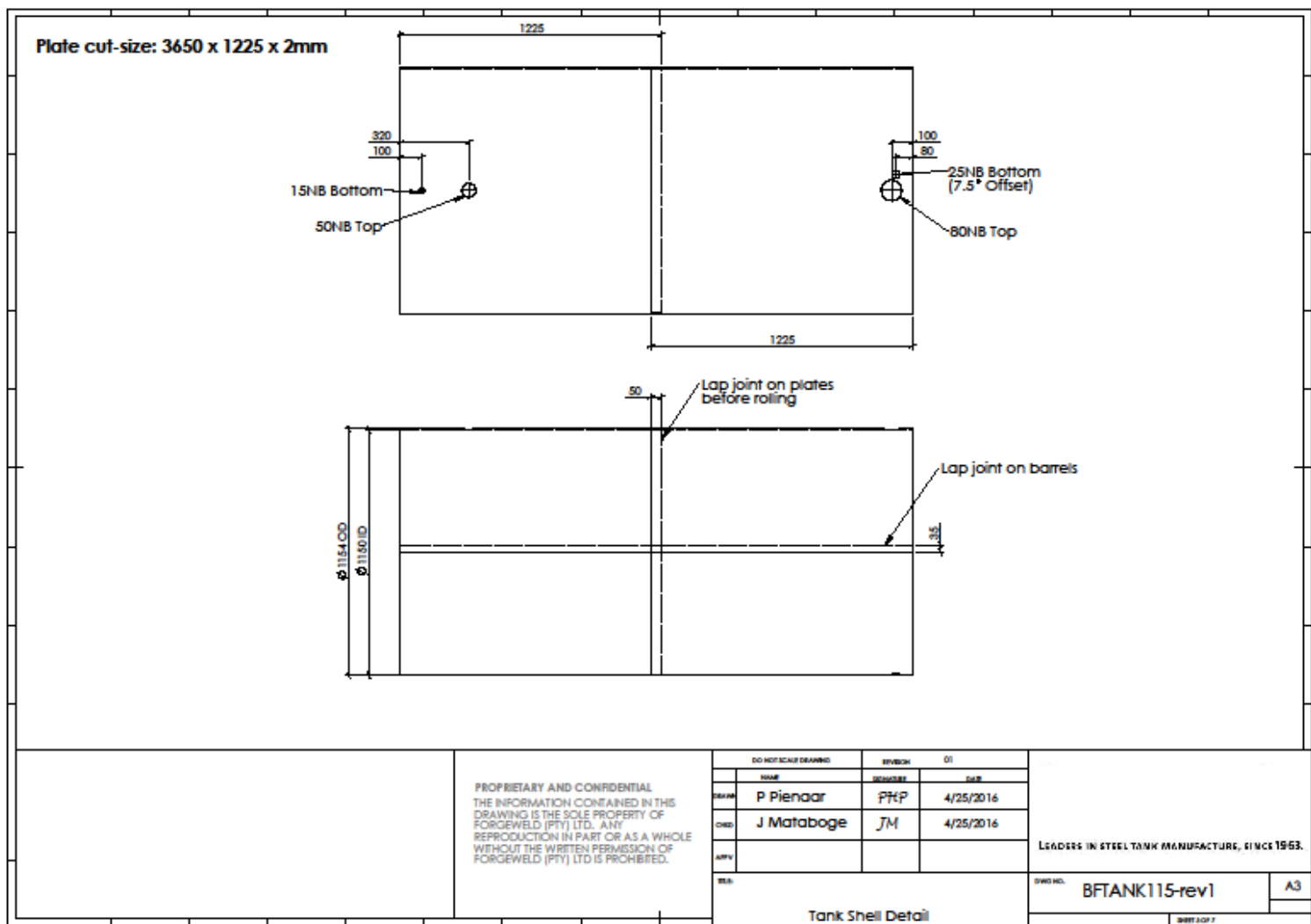

Initial

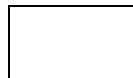

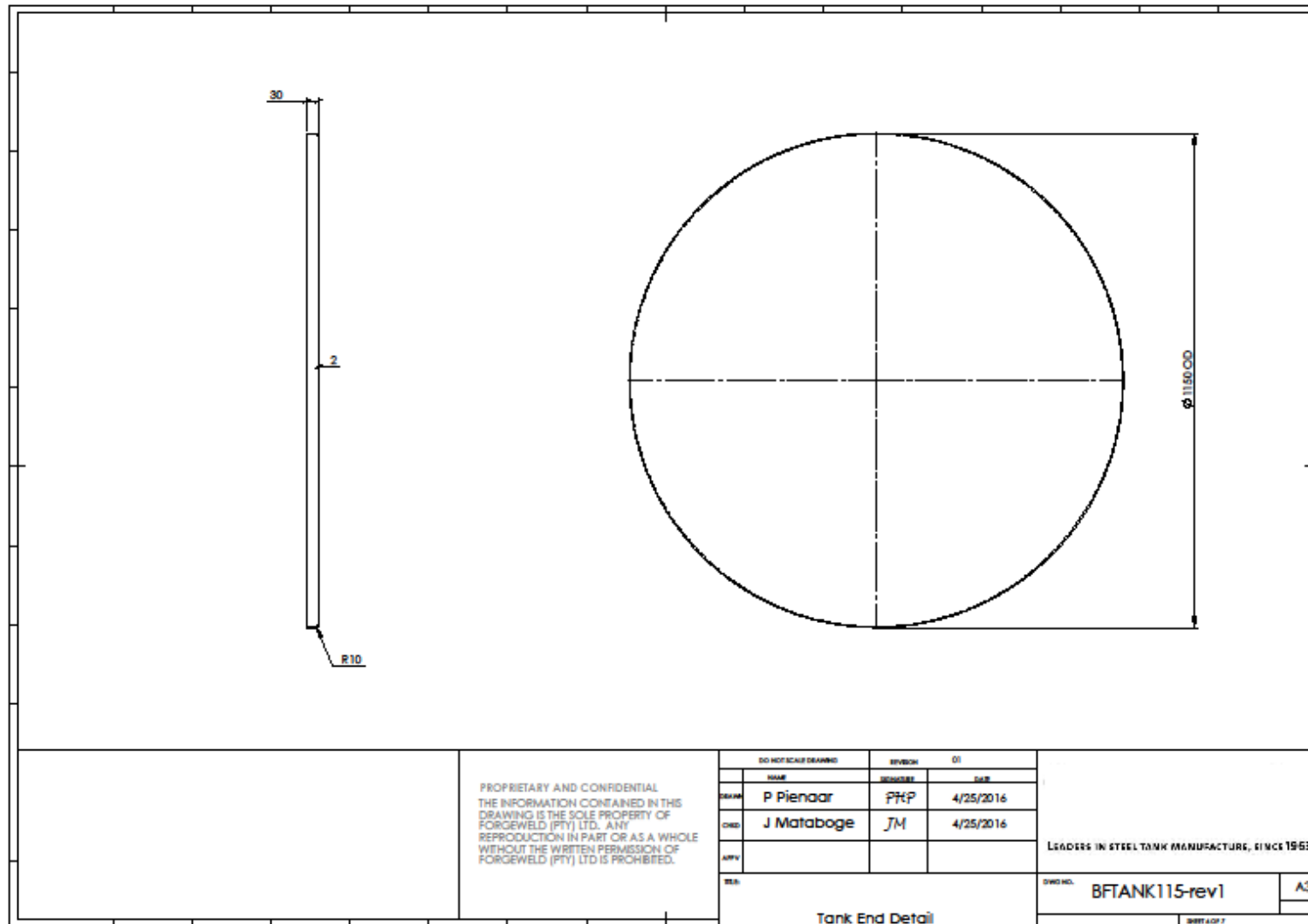

PROPRIETARY AND CONFIDENTIAL
 THE INFORMATION CONTAINED IN THIS
 DRAWING IS THE SOLE PROPERTY OF
 FORGEWELD (PTY) LTD. ANY
 REPRODUCTION IN PART OR AS A WHOLE
 WITHOUT THE WRITTEN PERMISSION OF
 FORGEWELD (PTY) LTD IS PROHIBITED.

DO NOT SCALE DRAWING	REVISION	BY
NAME	REVISION	DATE
DESIGN P Pienaar	PHP	4/25/2016
CHKD J Mataboge	JM	4/25/2016
APPV		

LEADERS IN STEEL TANK MANUFACTURE, SINCE 1953.

Tank End Detail

DWG NO. BFTANK115-rev1
 SHEET 1 OF 1
 A3

Initial



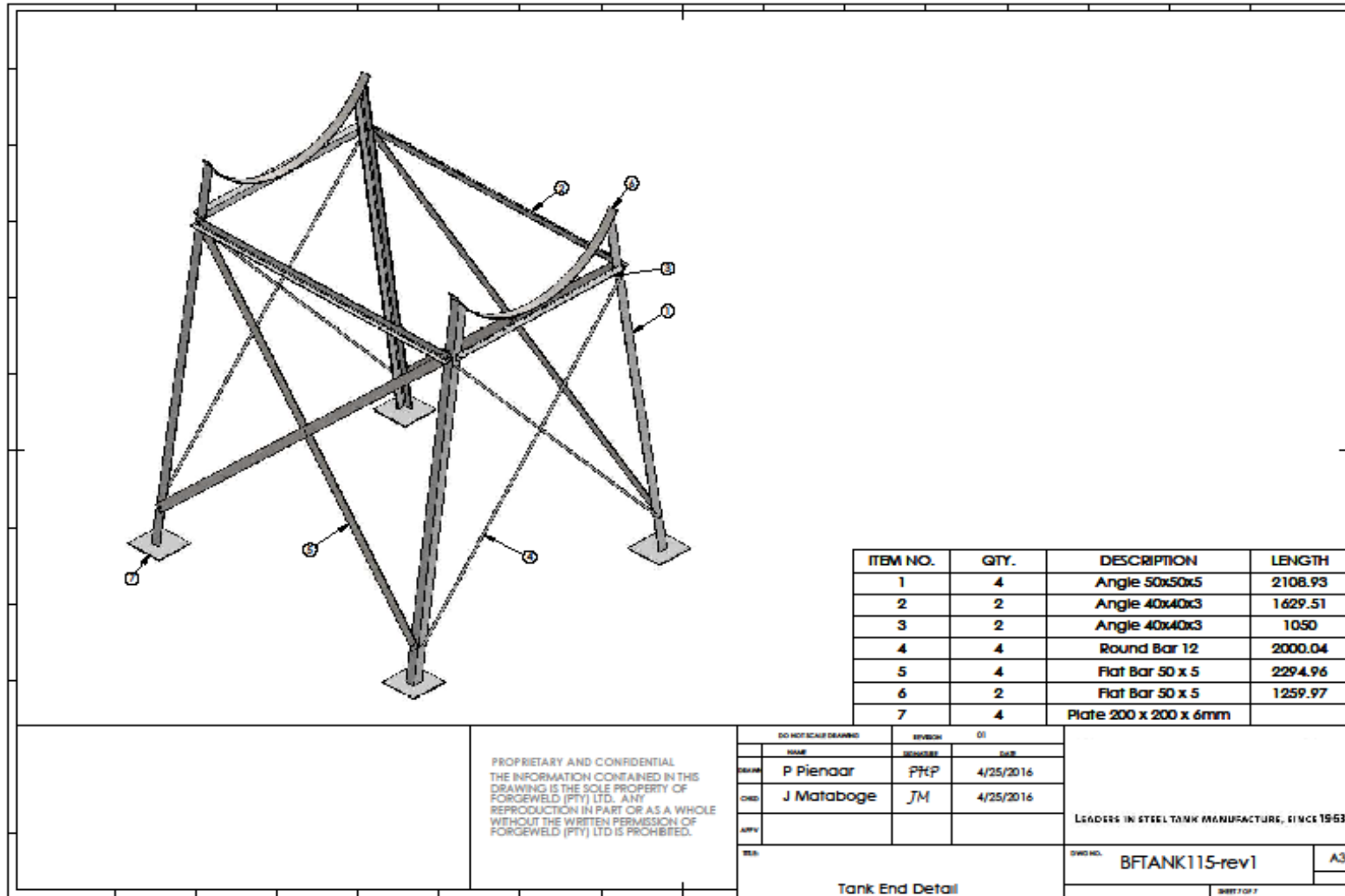

Initial

